



FERNE

have a seat.

COLLECTION 2026 / 27

have a seat.

have a seat.

have a seat.

have a seat.

have a seat.

have a seat.

have a seat.

have a seat.

FERNE

have a seat.



Core Collection

Brene collection



p. 6 - 9

Nexo collection



p. 10 - 13

Rimo collection



p. 14 - 19

Milane collection



p. 20 - 23

Lottie collection



p. 24 - 26

Premo collection



p. 24 - 27

Leco collection



New

p. 28 - 30

Turino collection



p. 28 - 31

Treno collection



New

p. 31



matte smooth surface

Vessco collection



New

p. 34 - 45

Capre collection



New

p. 36 - 37

Geno collection



New

p. 38

Maleno collection



New

p. 39

Cone collection



New

p. 40 - 43

Oveo collection



New

p. 44 - 45

Solco collection



New

p. 46 - 47

Modue collection



New

p. 48 - 49

structured surface

Senvo collection



New

p. 50 - 53

Trito collection



New

p. 54 - 55

Giore collection



New

p. 56 - 57

Cuplo collection



New

p. 58 - 59

Lanzo collection



New

p. 60 - 63

Soro collection



New

p. 64 - 65



Timeless and light beauty.

The projects are marked by visual lightness and elegance, which match both modern and classic spaces. The cohesive colour palette has been carefully designed to create one-of-a-kind arrangements by freely combining pieces in different colours. All of the above makes the BRENE collection perfect for versatile uses.

When designing the furniture, we placed emphasis on human-oriented ergonomics, with the users' needs in mind. The seats and backrests are made of breathable slats and they adapt naturally to the body shape for ultimate comfort. All the items in the collection are lightweight and easy to carry. Their construction prevents water pooling, so they are hard-wearing and easy to clean as well. With its top-notch quality, durability, and timeless design, the BRENE collection is made to last. What's more, particular pieces can be stacked, which makes their storage extremely convenient.

FERNE



Brene



Chair

FBRK558

520 x 530 x 825



Chair with armrests

FBRK658

575 x 530 x 825



Side table

FBR554

545 x 535 x 415



Coffee table

FBR5884

795 x 795 x 405



Armchair

FBRK767

670 x 625 x 740



Bar chair

FBRK5510

515 x 520 x 1015



Dining table

FBR888

795 x 795 x 755



Brene

The assortment includes chairs, a chair with armrests, an armchair, a dining table, a coffee table, and a side table. BRENE tables — built with the same slatted design — are solid yet airy, easy to maintain, and simple to assemble thanks to separately packed legs, improving logistics.

With its quality, functionality, and timeless character, BRENE is crafted to last — a harmonious blend of design heritage, comfort, and contemporary usability.





Timeless and light beauty.

NEXO is a collection inspired by architecture — born out of a fascination with form and designed with everyday comfort in mind. Its defining feature is perforation: a rhythmic pattern of elongated, rounded openings that give the forms a sense of visual lightness, evoking both modernist and contemporary architectural facades. The fusion of bold design and functionality makes NEXO a modern, versatile solution — perfectly suited to private and public spaces, both indoors and outdoors. The collection includes an armchair, chairs with and without armrests, a barstool, and a table.

FERNE



Nexo



Chair

FNEK558

490 x 545 x 810



Chair with armrests

FNEK658



595 x 545 x 810





Armchair

FNEK767

675 x 620 x 730



Bar chair

FNEK5510

515 x 500 x 1010



Side table

FNES64

635 x 550 x 400

Nexo

The NEXO collection includes an armchair, chairs with and without armrests, a bar chair, and a table — all combining ergonomics, aesthetics, and durability. Contoured seats, smooth edges, and refined backrest angles ensure lasting comfort, while lightweight, weather-resistant plastic and a perforated structure enhance airflow and prevent water accumulation. All seating pieces are stackable for easy storage and transport.

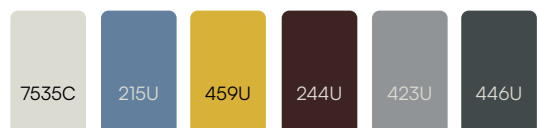



Light classic collection.

The RIMO collection combines the elegance of classic bentwood furniture with modern design and functionality. Here, tradition meets innovation, and the classic form is paired with modern moulding methods and materials. The gentle rounded shapes that allude to Thonet's designs are coupled with stylish colours to give the furniture a delicate and fashionable look.

The smooth lines and "bent" elements create a harmonious combination of classic design and modern solutions. Made with precision and attention to detail, the collection is of prime quality. The RIMO furniture is functional and comfortable while retaining timeless aesthetics. It offers an affordable alternative to traditional wooden chairs.

The collection comprises a chair, a chair with armrests, an armchair, two bar chairs of different heights, a round side table, a round high side table, coffee tables, and dining tables.

FERNE



Rimo



Chair

FRIK568

475 x 555 x 840



Chair with armrests

FRIK658

570 x 555 x 840



Armchair

FRIK667

620 x 625 x 748



Low bar chair

FRIK5510

520 x 545 x 985



High bar chair

FRIK5511

520 x 545 x 1075



Rimo

The RIMO chairs combine classic design with modern functionality, offering both refined aesthetics and high comfort. Carefully tested ergonomics and optimised weight ensure a pleasant seating experience, while the stackable construction allows easy rearrangement and storage. Rubber feet enhance stability and user comfort.

The RIMO bar chairs, available in two heights, echo the same timeless elegance. Their gentle curves, light construction, and refined details make them a stylish addition to both indoor and outdoor spaces.

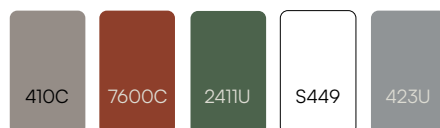

structure effect



Square coffee table

FRIS884

775 x 775 x 405



Coffee table

FRIS864

775 x 575 x 405



Square dining table

FRIS887

775 x 775 x 745



Dining table

FRIS867

775 x 575 x 745

structure effect



Side table

FRIS64

593 x 570 x 405



High side table

FRIS67

570 x 570 x 745

Rimo

The RIMO tables — square, rectangular and round — are elegant, robust, and carefully crafted, making them ideal for homes, gardens, cafés, and leisure spaces. Their universal design and weather-resistant construction allow them to blend seamlessly into terraces, patios, and indoor areas, bringing functional elegance to any setting.

All tables feature separately packed legs for easy assembly, supporting more efficient transport and storage. With their solid build and timeless aesthetic, RIMO tables offer a practical and stylish solution for a wide range of arrangements

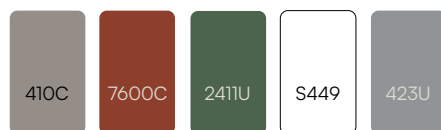

structure effect



Available comfort.

MILANE is an impressive collection of comfortable garden furniture. Its characteristics include the minimalist style, exceptional sitting comfort, and simple logistics. As monolithic forms are very popular among users, we have decided to create an entire collection in this spirit. By optimising the production process, we've made sure the collection is affordable for the wide public.

With their distinctive bends and soft shapes, all the pieces look strong and attractive, ensuring stability and durability. The single-point injection technology used in the MILANE collection created the smooth shapes of the furniture, emphasised by the satin finishing. The collection offers an array of subtle, timeless colours. MILANE comprises a chair, a chair with armrests, an armchair, sofa, coffee table and an side table that can also serve as a stool.

FERNE



Milane



Chair

FMIK667

580 x 600 x 735



Chair with armrests

FMIK768

680 x 600 x 805



Armchair

FMIK777

745 x 730 x 735



Sofa

FMIK1277

1200 x 735 x 732



Coffee table

FMIS863

790 x 590 x 340



Side table & stool

FMIS554

485 x 485 x 420

Milane

The Milane collection is an ideal choice for garden design. A two-seater sofa, an armchair, a coffee table and a low side table, will enrich your outdoor space. The side table is distinguished by its elegance and versatility, serving as a table, stool, or footrest.

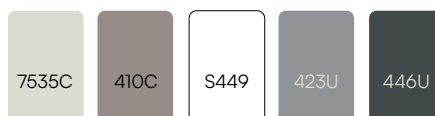



Perfect for interiors and gardens.

LOTTIE is a family of stylish and functional tables that will be a great fit for every type of garden or leisure space. The tables are very easy to clean, use and store. The family comprises a dining table, a coffee table, and a side table, which can also be used as a stool.

The LOTTIE products are available in classic, neutral colours, making them easy to pair with other FERNE items. Designed to enhance both interiors and gardens, the LOTTIE tables combine versatility and elegance, adding charm to any setting.

The chairs from the PREMO collection are available in three variants and perfectly complement the LOTTIE table collection, creating a cohesive and elegant arrangement for any space, both indoors and outdoors.

FERNE



Lottie & Premo



Side table & stool

FLOS445

396 x 396 x 465



Dining table

FLOS888

775 x 775 x 765



Coffee table

FLOS866

770 x 590 x 565

Lottie

The tables are very easy to clean, use, and store. The collection comprises a dining table, a coffee table, and a side table, which can be used as a stool.





Premo five
Chair with armrests

FPRK568

540 x 590 x 810



Premo six
Chair with armrests

FPRK658

590 x 560 x 815



Premo seven
Chair with armrests

FPRK758

630 x 560 x 825

Premo

PREMO is a modern interpretation of a classic garden chair. The product comes in three variants. It's perfect for places where quick rearrangements happen on a daily basis: the chairs can be easily moved in, out, and around, and they are convenient to store.

The PREMO chair is an attractive and functional solution for every balcony, garden, and stylish cafe. It has been carefully designed also in terms of colour and form.





Designed for everyday needs.

Two collections designed with everyday comfort, intuitive use and effortless storage in mind. These are pieces that require no effort — lightweight, practical and perfectly attuned to the relaxed rhythm of outdoor summer gatherings.

TURINO is an ergonomic chair with a stable construction, suitable for gardens, terraces and interior spaces alike. Thanks to its stackable design, it requires minimal storage space out of season, while its universal form complements a wide range of settings — from family get-togethers to open-air events.

LECO is a contemporary lounge set defined by well-balanced proportions, created for summer relaxation. Ideal for unwinding on terraces, in gardens or within chill-out areas. Its clean design, comfortable seating and ease of use allow LECO to feel equally at home in private spaces and retail-oriented environments.

These are solutions that sell well, store easily and are even easier to use — perfectly suited to the summer season, outdoor events and everyday leisure.

FERNE



Leco & Turino



New
Armchair

FLEK887

790 x 795 x 680



New
Armchair

FLEK877

790 x 750 x 660



New
Coffee table

FLES753

705 x 525 x 300

Leco

The LECO collection brings a fresh take on modern lounge furniture, combining clear design lines with balance and ease. Designed for both indoor and outdoor living, its generous shapes feel light and stable, offering comfort and effortless style across terraces, gardens and interiors.

Each piece is designed with practicality in mind — featuring precise proportions, stackable construction and easy handling. The LECO lounge set, which includes two armchairs and a coffee table, blends simplicity, comfort and timeless appeal for contemporary spaces.





New
Chair with armrests

FTRK658

595 x 550 x 810

Treno

Designed for everyday comfort and practical use, this chair with armrests combines a lightweight form with a versatile character. The wide seat provides comfort, while the integrated armrests reinforce a cohesive and functional design. Easy to move and stackable for efficient storage, it performs equally well in private interiors and commercial environments, including the HoReCa sector.

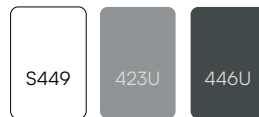

**New
Season
2027**



Chair with armrests

FTUK668

630 x 555 x 775

Turino

This comfortable chair, made from durable plastic, stands out with its modern design and ergonomic construction. The wide, supportive seat and integrated armrests provide excellent comfort, while the gently angled backrest supports a natural sitting posture. A practical opening in the backrest makes the chair easy to carry and helps drain rainwater. Stable, widely spaced legs ensure safe use on a variety of surfaces. Perfect for outdoor use, it is weather-resistant and easy to clean. The stackable design allows for space-saving storage.



A photograph of a modern outdoor furniture set in a lush garden. The set consists of two white plastic chairs and a matching white plastic coffee table, all with a minimalist, curved design. They are placed on a wooden deck. In the background, there are dense green trees and a dark grey structure with a white grid pattern. The overall scene is bright and natural.

New

Shaped by Motion

K BAR

The new FERNE collections are defined by rotomoulding technology and a clear, refined design vision.

FERNE explores the boundaries of material and form, transforming technological innovation into the language of contemporary design. It is a space where imagination meets precision, and where creativity unfolds freely, supported by advanced production methods.

Rotomoulding offers complete freedom of form. Fluid geometries, sculptural silhouettes and meticulously crafted details emerge without compromise — shapes that are impossible to achieve using traditional techniques. During the process, the material rotates at high temperatures, gradually coating the interior of the mould and creating seamless, uniform structures of exceptional durability.

These collections introduce a new dimension of resilience and expressive geometry. Monolithic, robust and pleasantly tactile, they embody the brand's character, the purity of form and the inherent strength of the material.



colour basic

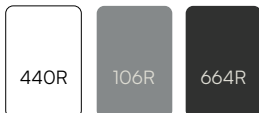

colour special order p. 66



New
Armchair

FVEK887R

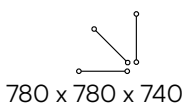

New
Stool

FVEK763R

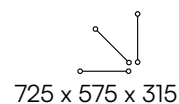

New
Sofa

FVEK1787R

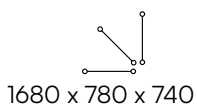

New
Coffee table

FVES863R

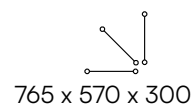

The even, fine-grained texture gives the furniture a consistent matte finish. Subtle discolouration is an intentionally designed effect resulting from the pigment blend used.



**matte smooth
surface**

Vessco

The VESSCO collection offers a contemporary interpretation of a sculptural volume. Soft, full shapes draw attention with their simplicity and balanced proportions. Rounded lines, gentle transitions and a solid, silhouette define the collection, giving the furniture an inviting, calming character that encourages a moment of rest.

The VESSCO coffee table completes the collection with its rounded, expressive form. Its fluid geometry mirrors the other pieces, creating a cohesive set that works beautifully on terraces, in lounge areas and in spacious interiors.



New Lounger

FCAK1568R

1495 x 590 x 835



FCAK1568R



FCAK1867R



New Lounger

FCAK1867R

1790 x 590 x 695

Capre

CAPRE is a sculptural lounger drawing from the refined aesthetics of Roman villas and the gardens of the island of Capreae. Its monolithic form combines solidity with elegance, while its fluid, ergonomic lines follow the natural shape of the body, offering exceptional comfort.

Evoking the symmetry and balance of classical architecture, CAPRE brings a sense of calm and luxury to any space — from terraces and gardens to spa areas and interiors — transforming them into places of quiet and rest.

colour basic

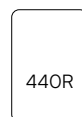

440R



106R

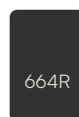

664R

colour special order p. 66

The even, fine-grained texture gives the furniture a consistent matte finish. Subtle discolouration is an intentionally designed effect resulting from the pigment blend used.

**New
Season
2027**

**matte smooth
surface**



have a seat.

Geno

The GENO table is a compact form defined by its shape and refined proportions. Its gently tapered silhouette gives it a sense of lightness despite its monolithic, solid construction. Thanks to its versatility, GENO can serve as a side table, a coffee table, or a standalone design accent within a space.

Its minimalist shape and smooth surface emphasise its contemporary character.

Subtle yet significant, GENO brings the composition to completion and provides balance, naturally harmonising with the other elements of the FERNE collection.

colour basic

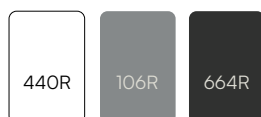

colour special order p. 66



New Side table

FGES544R

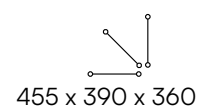

New Coffee table

FGES644R

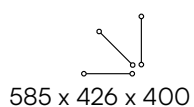

The even, fine-grained texture gives the furniture a consistent matte finish. Subtle discolouration is an intentionally designed effect resulting from the pigment blend used.



**matte smooth
surface**

colour basic



colour special order p. 66



New
Bar chair

FMAK447R

390 x 385 x 735

The even, fine-grained texture gives the furniture a consistent matte finish. Subtle discolouration is an intentionally designed effect resulting from the pigment blend used.

Maleno

MALENO is a bar chair of distinctive character, shaped from a single, fluid form. It brings together the raw quality of the material with carefully refined detailing, creating the impression of a sculpted, cohesive volume.

Its dynamic silhouette and soft, flowing geometry lend it a contemporary, subtly eclectic presence. MALENO offers a modern interpretation of minimalism — expressive, functional and designed to withstand outdoor conditions. It performs beautifully in both private and commercial settings, from terraces and bars to lounge areas and hotel spaces.



New
Chair

FCOK668R

590 x 650 x 750



New
Armchair

FCOK787R

700 x 750 x 700



New
Sofa

FCOK1587R

1500 x 750 x 740

The even, fine-grained texture gives the furniture a consistent matte finish. Subtle discolouration is an intentionally designed effect resulting from the pigment blend used.

Cone

The CONE collection is defined by flowing lines and gently shaped volumes that give it a sense of lightness and contemporary elegance.

The line includes a chair, an armchair and a sofa — all featuring an open structure and softly rounded edges. Their smooth curves introduce a subtle sense of dynamism while ensuring comfort in everyday use. Designed for spaces where comfort meets a modern, balanced aesthetic, CONE brings a refined and contemporary character to any space.

colour basic



colour special order p. 66

**matte smooth
surface**



have a seat.



New
Small coffee table

FCOS663R

560 x 560 x 300



New
Medium coffee table

FCOS764R

740 x 580 x 400

Cone

The collection is complemented by a small table and a medium coffee table, both following the same fluid, cohesive design language.

Their silhouettes complete the seating elements, forming a unified and elegant lounge ensemble — suitable for both interior spaces and outdoor areas.

colour basic

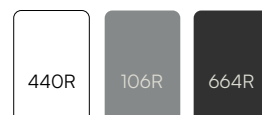

colour special order p. 66

The even, fine-grained texture gives the furniture a consistent matte finish. Subtle discolouration is an intentionally designed effect resulting from the pigment blend used.

**matte smooth
surface**



have a seat.



New
Compact table

FOVS553R

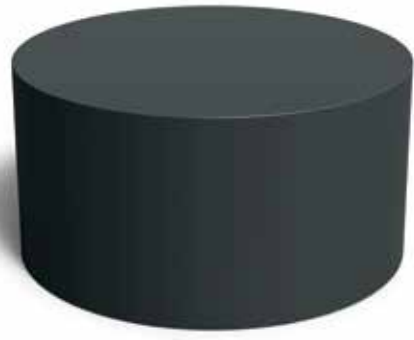

460 x 460 x 250



New
Small table

FOVS663R

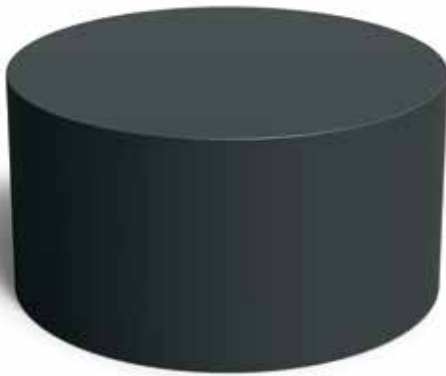

590 x 590 x 310



New
Medium table

FOVS774R

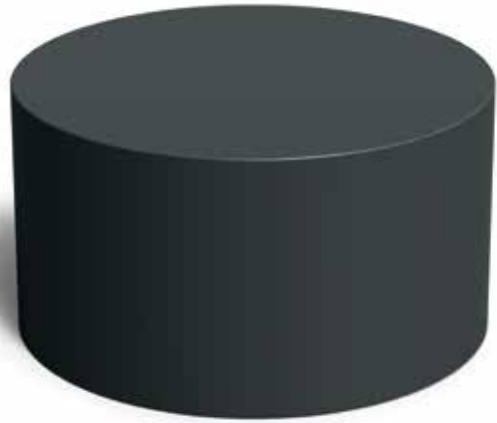
720 x 720 x 370



New
Large table

FOVS884R

780 x 780 x 370

The even, fine-grained texture gives the furniture a consistent matte finish. Subtle discolouration is an intentionally designed effect resulting from the pigment blend used.

colour basic



Colour switch list
see more / p. 66





matte smooth surface

Ergonomic packing and transport system enables nesting of furniture units, resulting in more efficient use of transport and storage space and optimised logistics costs.

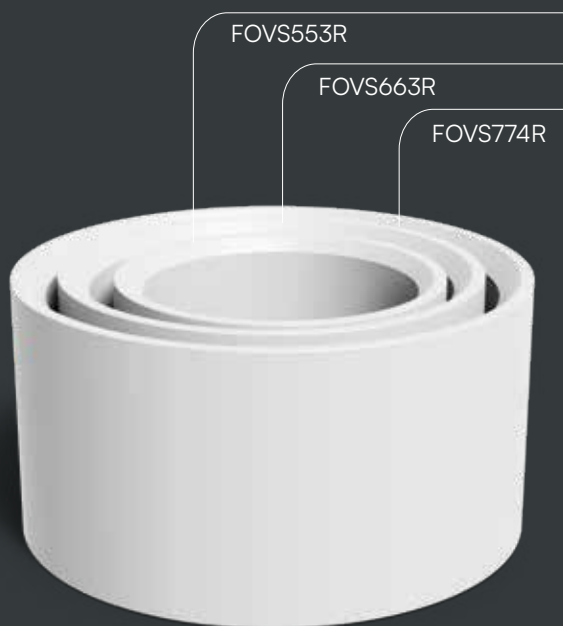

Oveo

Oveo is a collection of four round tables defined by a timeless circular shape and a minimalist form. Their simple construction with an open base gives them a sense of lightness and a contemporary character.

Thanks to their thoughtfully designed geometry, three of the smaller tables can be slid under one another, making storage easier and allowing the arrangement to adapt seamlessly to different spatial layouts. With their universal and time-honoured aesthetic, Oveo tables harmonise naturally with both modern and classic settings. They are durable, stable and resistant to outdoor conditions, making them ideal for interiors, terraces, gardens and commercial spaces.

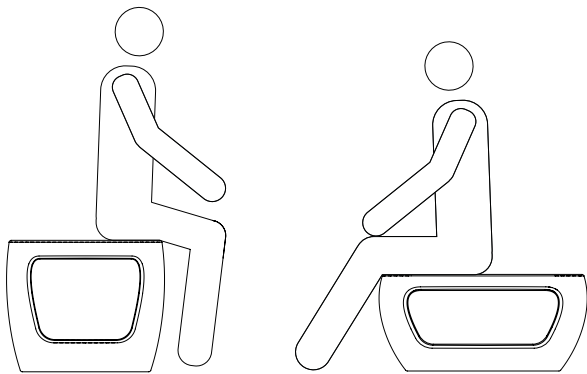

New Coffee table

FSLS864R

780 x 600 x 360



New Side table

FSLS645R

590 x 400 x 500

The even, fine-grained texture gives the furniture a consistent matte finish. Subtle discolouration is an intentionally designed effect resulting from the pigment blend used.

Solco

SOLCO is a collection of coffee tables defined by an open form that remains in a clear relationship with the surrounding space. The softly modelled, monolithic volume is articulated by a distinctive central cut-out, introducing lightness and a strong contemporary expression.

The opening not only defines the form but also allows light to pass freely through the object, enhancing its sculptural quality.

The varied proportions of the models enable cohesive yet dynamic compositions. SOLCO performs equally well in modern interiors, lounge areas and refined outdoor settings.

colour basic



colour special order p. 66

**New
Season
2027**

**matte smooth
surface**



have a seat.

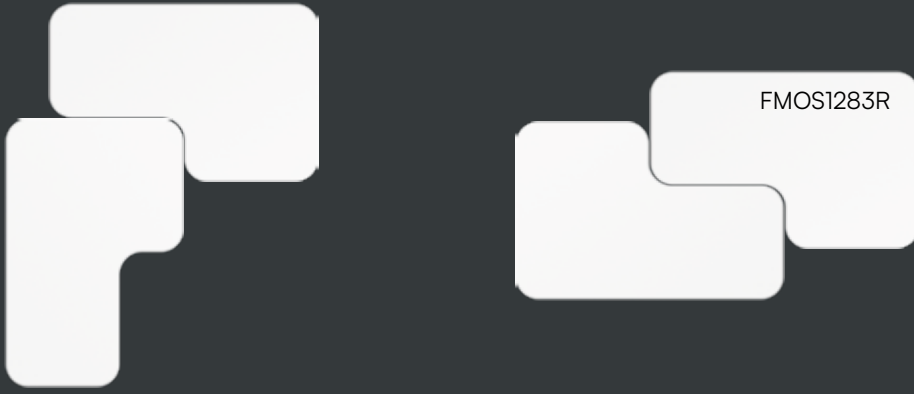

Shape your layout



New
Season
2027

matte smooth
surface



New
Coffee table

FMOS883R

780 x 780 x 330



Module

MODULE is a collection of low tables designed around the idea of modularity and flexible arrangement of elements. Its distinctive L-shaped form allows individual elements to be combined into larger arrangements, including complete rectangular tables adapted to changing user needs. The monolithic, softly modelled volume with rounded edges gives the collection a cohesive and contemporary character, while emphasising its functional logic. The variety of configurations enables dynamic yet balanced arrangements, from compact layouts to larger, clearly defined compositions with an ordered geometry. MODULE performs equally well in modern interiors and outdoor settings, offering flexibility and visual consistency across layouts.

colour basic



colour special order p. 66



New
Large coffee table

FMOS1283R

1180 x 780 x 330

The even, fine-grained texture gives the furniture a consistent matte finish. Subtle discolouration is an intentionally designed effect resulting from the pigment blend used.



**New
Season
2027**

**structured
surface**



Senvo



New
Side table

FSES643R

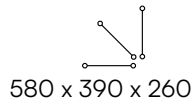

New
Small coffee table

FSES753R

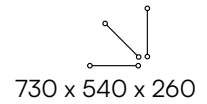

New
Medium coffee table

FSES863R

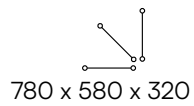

New
Large coffee table

FSES1083R

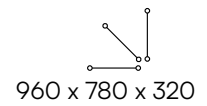

New
Lounge table

FSES12103R

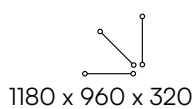

New
Bistro table

FSES888R

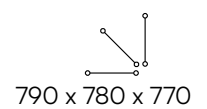

New
Season
2027

structured
surface



Senvo

SENVO is a collection of tables with a distinctly structural surface, inspired by the Japandi aesthetic, combining Scandinavian simplicity with a Japanese approach to proportion and space.

The series includes low tables, coffee tables, and one higher piece, forming a cohesive system with varied functions. Its fluid, minimalist form, rounded edges, and wide, low-set tabletops emphasize horizontality and a close relationship to the ground.

SENVO brings a sense of calm and balance, fitting seamlessly into both private and commercial interiors.

Furniture with a distinctly porous, grainy surface and rough edges. Subtle discolouration is an intentionally designed effect and results from the colouring process.

colour basic



Colour swatch list
see more / p. 67



New
Side table

FTIS63R

580 x 580 x 290



New
Coffee table

FTIS84R

780 x 780 x 360

Trito

TRITO is a collection of coffee and side tables defined by a base composed of three massive cylindrical forms, creating a strong, distinctive rhythm. Its bold geometry allows the tables to function as standalone accents or to be combined into cohesive, rhythmic compositions across private and commercial spaces.

colour basic



colour special order p. 67

Furniture with a distinctly porous, grainy surface and rough edges. Subtle discolouration is an intentionally designed effect and results from the colouring process.

New
Season
2027

structured
surface



colour basic



colour special order p. 67



New
Lounge table

FGIS863R

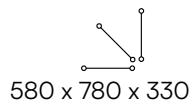

New
Large coffee table

FGIS884R

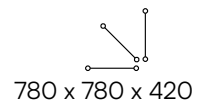

New
Medium coffee table

FGIS766R

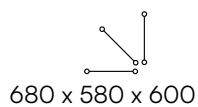

New
High side table

FGIS547R

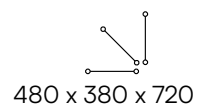

Furniture with a distinctly porous, grainy surface and rough edges. Subtle discolouration is an intentionally designed effect and results from the colouring process.

New
Season
2027

structured
surface



Giore

GIORE is a modular collection of tables with a simple, rectangular form, rooted in minimalism and clear geometry. The architectural volume is broken by an asymmetrical arrangement, where the tabletop is offset in relation to the base.

The offset not only defines the aesthetic but also enhances functionality, allowing for convenient placement against a wall and the creation of practical configurations using elements of varying heights and proportions. Softly rounded edges balance the rawness of the form, introducing a more refined, contemporary expression. GIORE works equally well as a standalone accent or within more developed, rhythmic compositions across private and commercial spaces.



New
Side table

FCUS43R

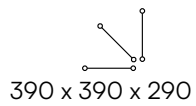

New
Coffee table

FCUS63R

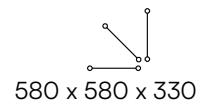

New
High side table

FCUS45R

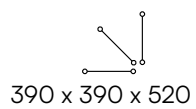

New
High side table

FCUS55R

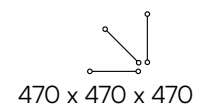

Furniture with a distinctly porous, grainy surface and rough edges. Subtle discolouration is an intentionally designed effect and results from the colouring process.

New
Season
2027

structured
surface



New
High coffee table

FCUS64R

580 x 580 x 430

Cuplo

CUPLO is a collection of round tables defined by a soft, sculptural form, in which the smoothly modelled base gives the form its distinctive, rounded character. Each model is shaped through a seamless transition between the top and the base, creating a cohesive, organic whole.

The individual variants differ in height and proportions, from lower, more expansive forms to taller, more slender models. This diversity allows for flexible compositions and enables the tables to be adapted to different functions and spatial arrangements.

With its fluid lines and subtle presence, the CUPLO collection suits both modern minimalist interiors and softer, more intimate settings.

colour basic



colour special order p. 67



New
Season
2027

structured
surface



Lanzo



New
Side table

FLAS43R

390 x 390 x 340



New
Medium coffee table

FLAS63R

580 x 580 x 340



New
Large coffee table

FLAS83R

790 x 790 x 310

The even, fine-grained texture gives the furniture a consistent matte finish. Subtle discolouration is an intentionally designed effect resulting from the pigment blend used.

Lanzo

LANZO is a collection of coffee tables and side tables with a timeless character. Its fluid, minimalist silhouette is based on a round top set on a solid, sculptural base with a profile tapering upwards. The individual models vary not only in height but also in diameter and the geometry of the base, which ranges from more slender, vertical forms to lower, more compact volumes with a distinctly horizontal character. This variation allows for a deliberate play of proportions and enables both standalone accents and more complex, dynamic compositions.

colour basic



colour special order p. 67



New
High coffee table

FLAS65R

580 x 580 x 460



New
High side table

FLAS45R

390 x 390 x 490



New
High coffee table

FLAS87R

790 x 790 x 740

New
Season
2027

structured
surface





New
High coffee table

FSOS64R

580 x 580 x 360



New
Coffee table

FSOS83R

790 x 790 x 300



Soro

SORO is a collection of low tables defined by an elegant, balanced character. A round tabletop rests on a solid base with vertical fluting, giving the form rhythm and a distinct presence. The textured surface subtly interacts with light, creating a refined play of shadow and highlighting the sculptural quality of the piece. Inspired by details of classical architecture, the fluted base introduces a timeless and sophisticated expression. This makes SORO well suited to both modern, minimalist interiors and more atmospheric, refined settings, as well as commercial spaces.

colour basic



colour special order p. 67

Furniture with a distinctly porous, grainy surface and rough edges. Subtle discolouration is an intentionally designed effect and results from the colouring process.

colour basic

matte smooth
surface



mono white
440R



urban gray
106R

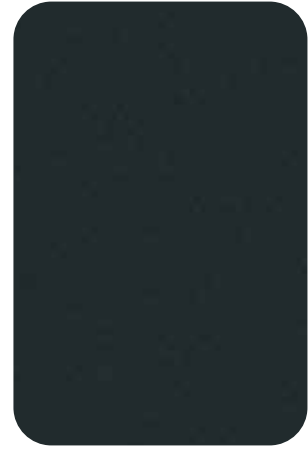

midnight anthracite
664R

colour special order



salt
102GR



macchiato
231R



red ochre
220R

colour basic

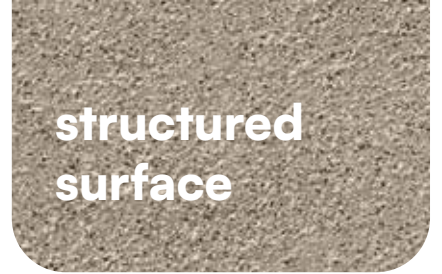

sand
101GR

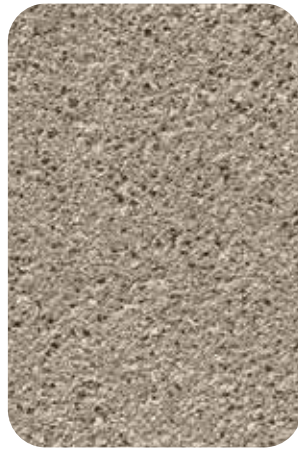

macchiato
231R



charcoal
109GR

colour special order



salt
102GR



lead
108GR



rust
200GR



corten steel
100GR

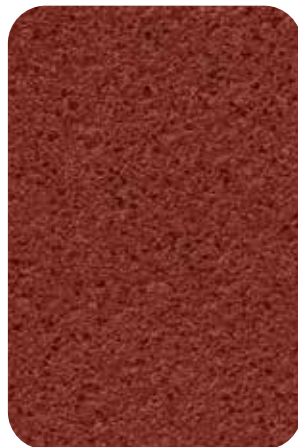

red ochre
220R

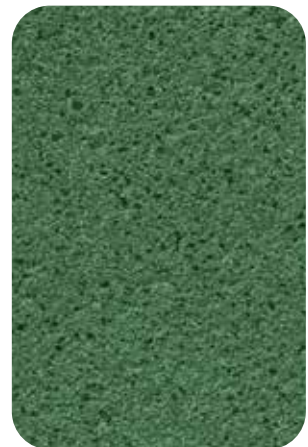

botanic green
300R

Core Collection

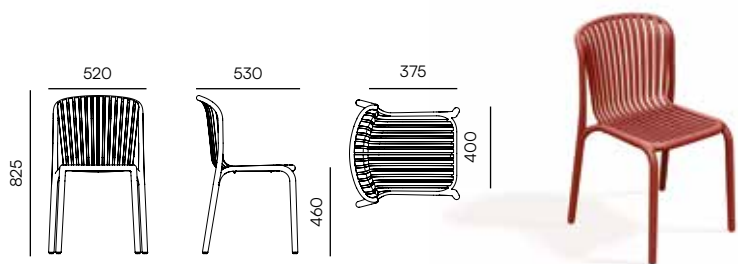

senza
7535C

retro red
3517U

verde
4193C

white
S449

agate gray
423U

carbon
446U

Brene

Chair

sku: dimensions (mm): length /width /height

FBRK558

520 x 530 x 825

maximum weight:

110

packaging (pcs):

24

pallet height:

~ 1700

stackable:

✓

Ask about more logistics options.

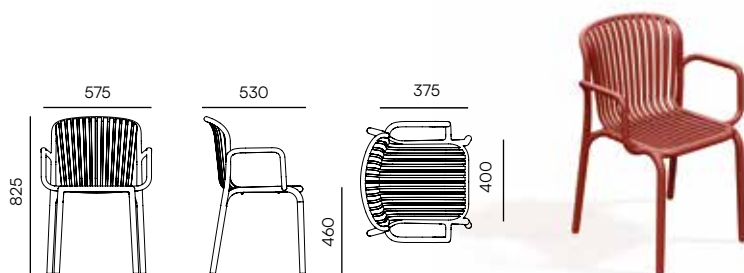

senza
7535C

retro red
3517U

verde
4193C

white
S449

agate gray
423U

carbon
446U

Brene

Chair with armrests

sku: dimensions (mm): length /width /height

FBRK658

575 x 530 x 825

maximum weight:

110

packaging (pcs):

24

pallet height:

~ 1700

stackable:

✓

Ask about more logistics options.

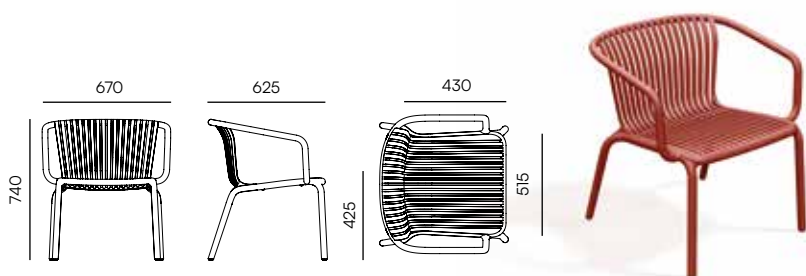

senza
7535C

retro red
3517U

verde
4193C

white
S449

agate gray
423U

carbon
446U

Brene

Armchair

sku: dimensions (mm): length /width /height

FBRK767

670 x 625 x 740

maximum weight:

110

packaging (pcs):

14

pallet height:

~ 1800

stackable:

✓

Ask about more logistics options.

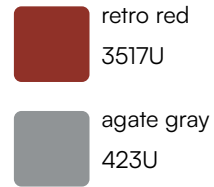
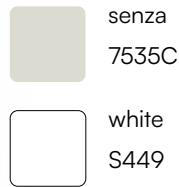
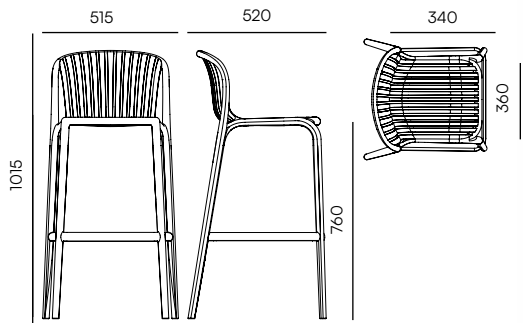

Brene
Bar chair

New FBRK5510

sku:	dimensions (mm): length /width /height
	515 x 520 x 1015

maximum weight:
110

packaging (pcs):
12

pallet height:
~ 1400

stackable:
✓

Ask about more logistics options.

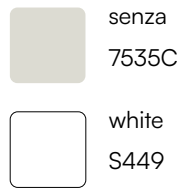
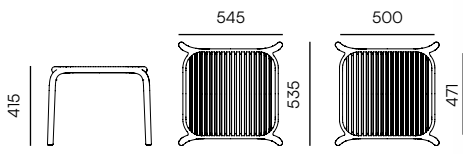

Brene
Side table

FBR554

sku:	dimensions (mm): length /width /height
	545 x 535 x 415

maximum weight:
50

packaging (pcs):
24 48

pallet height:
~ 1040 ~ 2080

stackable:
✓

Ask about more logistics options.

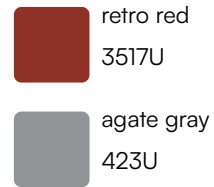
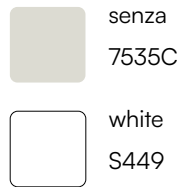
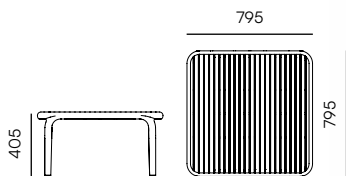

Brene
Coffee table

FBR5884

sku:	dimensions (mm): length /width /height
	795 x 795 x 405

maximum weight:
100

packaging (pcs):
12

pallet height:
~ 1805

stackable:
✓

Ask about more logistics options.

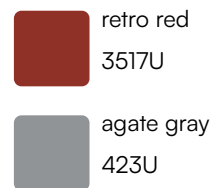
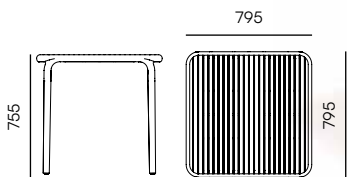

Brene
Dining table

FBR5888

sku:	dimensions (mm): length /width /height
	795 x 795 x 755

maximum weight:
100





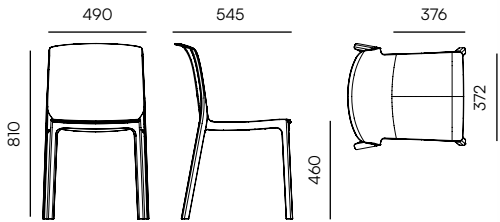

packaging (pcs):
12

pallet height:
~ 1805

stackable:
✓

Ask about more logistics options.







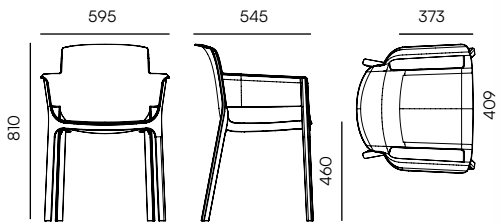

 senza 7535C	 denim blue 215U	 pop yellow 459U
 wine ink 244U	 agate gray 423U	 carbon 446U

Nexo Chair

sku:	dimensions (mm): length /width /height	maximum weight:	packaging (pcs):	pallet height:	stackable:
FNEK558	490 x 545 x 810	110	24	~ 1850	✓

Ask about more logistics options.







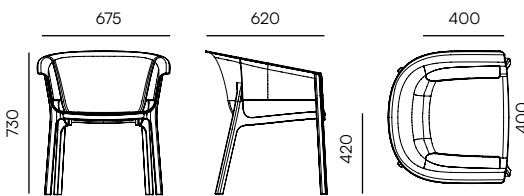

 senza 7535C	 denim blue 215U	 pop yellow 459U
 wine ink 244U	 agate gray 423U	 carbon 446U

Nexo Chair with armrests

sku:	dimensions (mm): length /width /height	maximum weight:	packaging (pcs):	pallet height:	stackable:
FNEK658	595 x 545 x 810	110	24	~ 1950	✓

Ask about more logistics options.







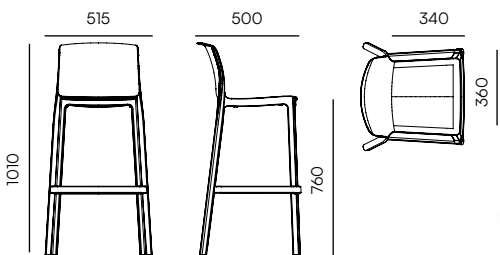

 senza 7535C	 denim blue 215U	 pop yellow 459U
 wine ink 244U	 agate gray 423U	 carbon 446U

Nexo Armchair

sku:	dimensions (mm): length /width /height	maximum weight:	packaging (pcs):	pallet height:	stackable:
FNEK767	675 x 620 x 730	110	12	~ 1850	✓

Ask about more logistics options.



 senza 7535C	 denim blue 215U	 pop yellow 459U
 wine ink 244U	 agate gray 423U	 carbon 446U

Nexo Bar chair

sku:	dimensions (mm): length /width /height	maximum weight:	packaging (pcs):	pallet height:	stackable:
FNEK5510	515 x 500 x 1010	110	12	~ 1400	✓

Ask about more logistics options.

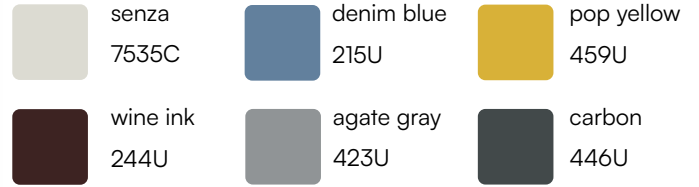
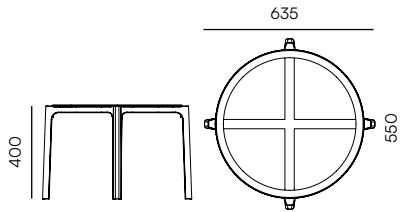

Nexo

Side table

sk#: FNES64

dimensions (mm): length /width /height	maximum weight:	packaging (pcs):	pallet height:	stackable:
635 x 550 x 400	50	54	~ 1850	✓

Ask about more logistics options.

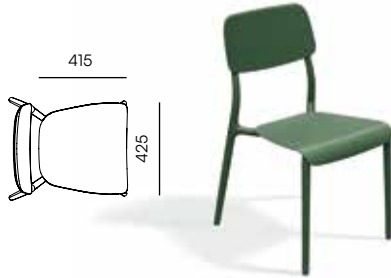
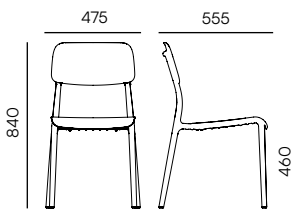

Rimo

Chair

sk#: FRIK568

dimensions (mm): length /width /height	maximum weight:	packaging (pcs):	pallet height:	stackable:
475 x 555 x 840	110	20	~ 1700	✓

Ask about more logistics options.

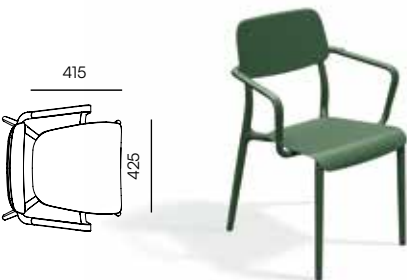
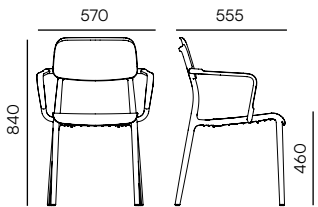

Rimo

Chair with armrests

sk#: FRIK658

dimensions (mm): length /width /height	maximum weight:	packaging (pcs):	pallet height:	stackable:
570 x 555 x 840	110	20	~ 1840	✓

Ask about more logistics options.

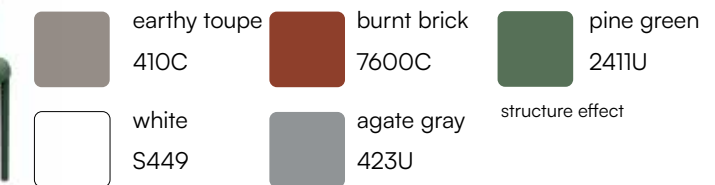
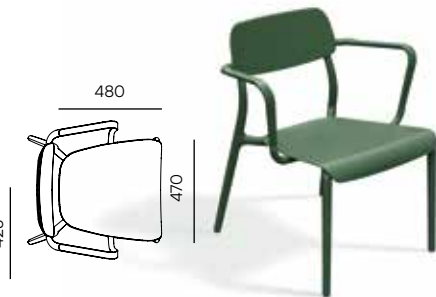
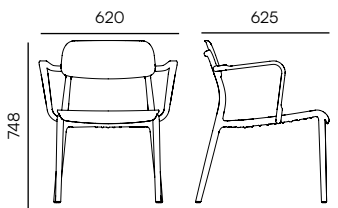

Rimo

Armchair

sk#: FRIK667

dimensions (mm): length /width /height	maximum weight:	packaging (pcs):	pallet height:	stackable:
620 x 625 x 748	110	16	~ 1800	✓



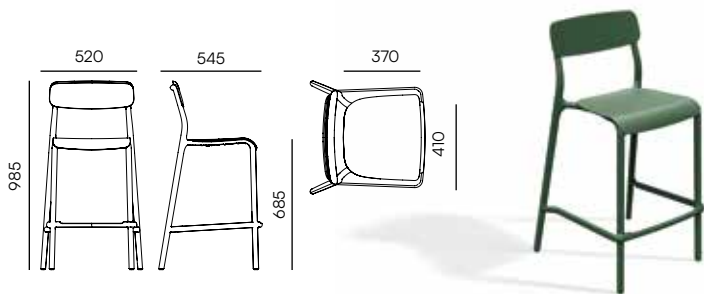

Ask about more logistics options.



-  earthy toupe 410C
-  burnt brick 7600C
-  pine green 2411U
-  white S449
-  agate gray 423U
- structure effect

Rimo

Low bar chair

sku:	 dimensions (mm): length /width /height	 maximum weight:	 packaging (pcs):	 pallet height:	 stackable:
FRIK5510	520 x 545 x 985	110	15	~ 1800	✓

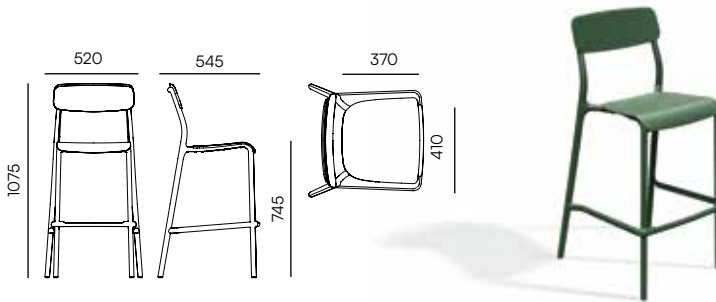

Ask about more logistics options.



-  earthy toupe 410C
-  burnt brick 7600C
-  pine green 2411U
-  white S449
-  agate gray 423U
- structure effect



Rimo

High bar chair

sku:	 dimensions (mm): length /width /height	 maximum weight:	 packaging (pcs):	 pallet height:	 stackable:
FRIK5511	520 x 545 x 1075	110	14	~ 1940	✓

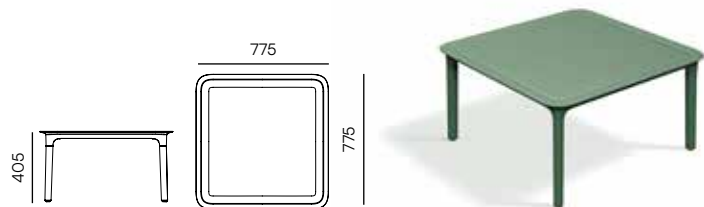



Ask about more logistics options.



-  earthy toupe 410C
-  burnt brick 7600C
-  pine green 2411U
-  white S449
-  agate gray 423U
- structure effect





Rimo

Square coffee table

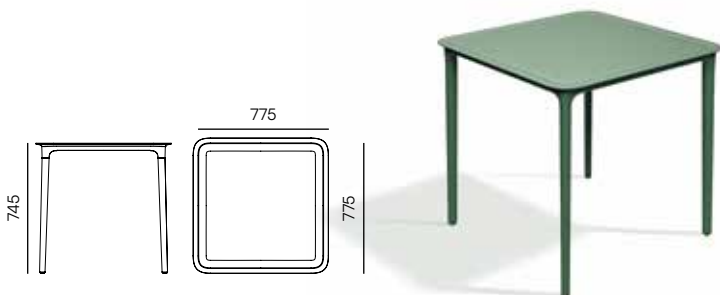
sku:	 dimensions (mm): length /width /height	 maximum weight:	 packaging (pcs):	 pallet height:	 stackable:
FRIS884	775 x 775 x 405	100	26	~ 1910	✓





Ask about more logistics options.



-  earthy toupe 410C
-  burnt brick 7600C
-  pine green 2411U
-  white S449
-  agate gray 423U
- structure effect

Rimo

Square dining table

sku:	 dimensions (mm): length /width /height	 maximum weight:	 packaging (pcs):	 pallet height:	 stackable:
FRIS887	775 x 775 x 745	100	26	~ 1910	✓

Ask about more logistics options.

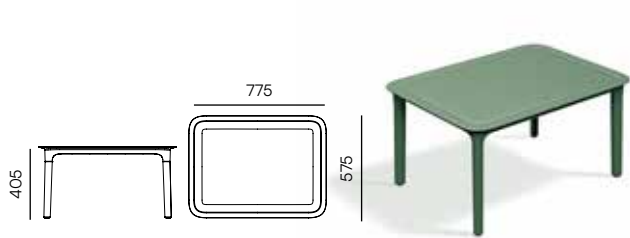

-  earthy toupe
410C
 -  white
S449
-  burnt brick
7600C
 -  agate gray
423U
-  pine green
2411U
 - structure effect

Rimo
Coffee table

FRIS864

sku:	dimensions (mm): length /width /height
	775 x 575 x 405

maximum weight:
100

packaging (pcs):
36

pallet height:
~ 1915

stackable:
✓

Ask about more logistics options.

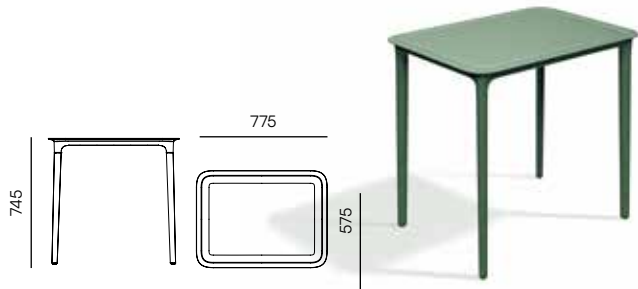

-  earthy toupe
410C
 -  white
S449
-  burnt brick
7600C
 -  agate gray
423U
-  pine green
2411U
 - structure effect

Rimo
Dining table

FRIS867

sku:	dimensions (mm): length /width /height
	775 x 575 x 745

maximum weight:
100

packaging (pcs):
36

pallet height:
~ 1915

stackable:
✓

Ask about more logistics options.

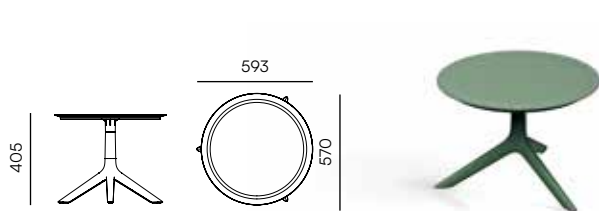

-  earthy toupe
410C
 -  white
S449
-  burnt brick
7600C
 -  agate gray
423U
-  pine green
2411U
 - structure effect

Rimo
Side table

FRIS64

sku:	dimensions (mm): length /width /height
	593 x 570 x 405

maximum weight:
50



packaging (pcs):
30

pallet height:
~ 1950

stackable:
✓

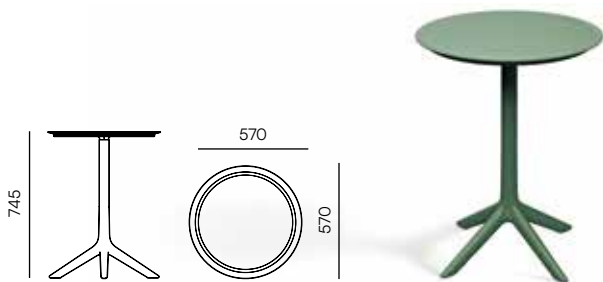
Ask about more logistics options.



-  earthy toupe
410C
 -  white
S449
-  burnt brick
7600C
 -  agate gray
423U
-  pine green
2411U
 - structure effect

Rimo
High side table

FRIS67

sku:	dimensions (mm): length /width /height
	570 x 570 x 745

maximum weight:
50

packaging (pcs):
30

pallet height:
~ 1950

stackable:
✓

Ask about more logistics options.

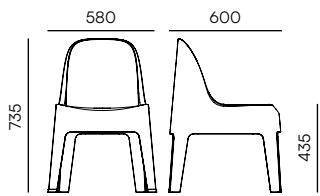

- senza 7535C
 earthy toupe 410C
 white S449
- agate gray 423U
 carbon 446U

Milane

Chair

sku:

dimensions (mm): length /width /height

maximum weight:

packaging (pcs):

pallet height:

stackable:

FMIK667

580 x 600 x 735

110

28

~ 1950

✓

Ask about more logistics options.

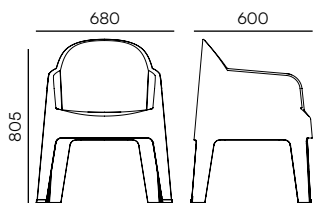

- senza 7535C
 earthy toupe 410C
 white S449
- agate gray 423U
 carbon 446U

Milane

Chair with armrests

sku:

dimensions (mm): length /width /height

maximum weight:

packaging (pcs):

pallet height:

stackable:

FMIK768

680 x 600 x 805

110

28

~ 1950

✓

Ask about more logistics options.

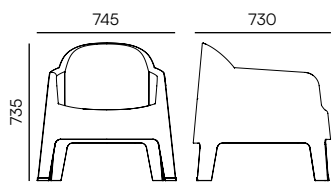

- senza 7535C
 earthy toupe 410C
 white S449
- agate gray 423U
 carbon 446U

Milane

Armchair

sku:

dimensions (mm): length /width /height

maximum weight:

packaging (pcs):

pallet height:

stackable:

FMIK777

745 x 730 x 735

110

18

~ 1830

✓

Ask about more logistics options.

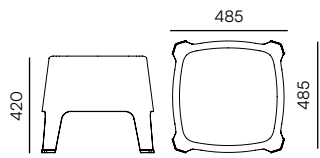

- senza 7535C
 earthy toupe 410C
 white S449
- agate gray 423U
 carbon 446U

Milane

Side table & stool

sku:

dimensions (mm): length /width /height

maximum weight:

packaging (pcs):

pallet height:

stackable:

FMIS554

485 x 485 x 420

110

64

~ 1900

✓

Ask about more logistics options.



- senza
7535C
- earthy toupe
410C
- white
S449
- agate gray
423U
- carbon
446U

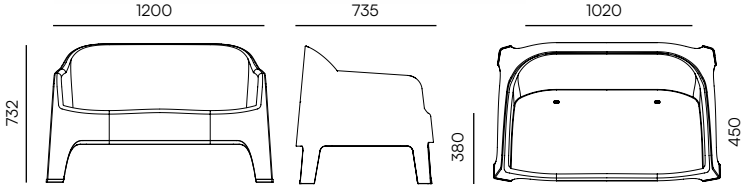

Milane

Sofa

sku: FMIK1277

sku:	dimensions (mm): length /width /height	maximum weight:	packaging (pcs):	pallet height:	stackable:
FMIK1277	1200 x 735 x 732	220	11	~ 1900	✓

Ask about more logistics options.



- senza
7535C
- earthy toupe
410C
- white
S449
- agate gray
423U
- carbon
446U

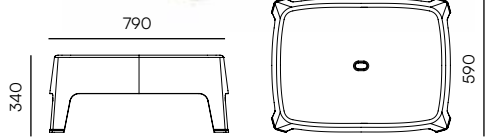

Milane

Coffee table

sku: FMIS863

sku:	dimensions (mm): length /width /height	maximum weight:	packaging (pcs):	pallet height:	stackable:
FMIS863	790 x 590 x 340	50	72	~ 1800	✓

Ask about more logistics options.



Leco

Armchair

New FLEK877

sku:	dimensions (mm): length /width /height
	790 x750 x 660

maximum weight:
110

packaging (pcs):
54

pallet height:
~ 1900

stackable:
✓

Ask about more logistics options.



Leco

Armchair

New FLEK887

sku:	dimensions (mm): length /width /height
	790 x 795 x 680

maximum weight:
110

packaging (pcs):
26

pallet height:
~ 1850

stackable:
✓

Ask about more logistics options.



Leco

Coffee table

New FLES753

sku:	dimensions (mm): length /width /height
	705 x 525 x 300

maximum weight:
50

packaging (pcs):
96

pallet height:
~ 1900

stackable:
✓

Ask about more logistics options.



Lottie

Side table & stool

FLOS445

sku:	dimensions (mm): length /width /height
	396 x 396 x 465

maximum weight:
110

packaging (pcs):
90

pallet height:
~ 1900

stackable:
✓

Ask about more logistics options.



- senza 7535C
- verde 4193C
- light gray 443U
- carbon 446U

Lottie

Coffee table

FLOS866

sku:	dimensions (mm): length /width /height	maximum weight:	packaging (pcs):	pallet height:	stackable:
FLOS866	770 x 590 x 565	100	30	~ 1850	✓

Ask about more logistics options.



- senza 7535C
- verde 4193C
- light gray 443U
- carbon 446U

Lottie

Dining table

FLOS888

sku:	dimensions (mm): length /width /height	maximum weight:	packaging (pcs):	pallet height:	stackable:
FLOS888	775 x 775 x 765	100	12	~ 1900	✓

Ask about more logistics options.



- senza 7535C
- earthy toupe 410C
- verde 4193C
- light gray 443U
- carbon 446U

Premo five

Chair with armrests

FPRK568

sku:	dimensions (mm): length /width /height	maximum weight:	packaging (pcs):	pallet height:	stackable:
FPRK568	540 x 590 x 810	110	30	~ 1740	✓

Ask about more logistics options.



- senza 7535C
- earthy toupe 410C
- verde 4193C
- light gray 443U
- carbon 446U

Premo six

Chair with armrests

FPRK658

sku:	dimensions (mm): length /width /height	maximum weight:	packaging (pcs):	pallet height:	stackable:
FPRK658	590 x 560 x 815	110	28	~ 1750	✓

Ask about more logistics options.



- senza 7535C
- earthy toupe 410C
- verde 4193C

Premo seven

Chair with armrests

sku:	dimensions (mm): length /width /height	maximum weight:	packaging (pcs):	pallet height:	stackable:
FPRK758	630 x 560 x 825	110	26	~ 1650	✓

Ask about more logistics options.

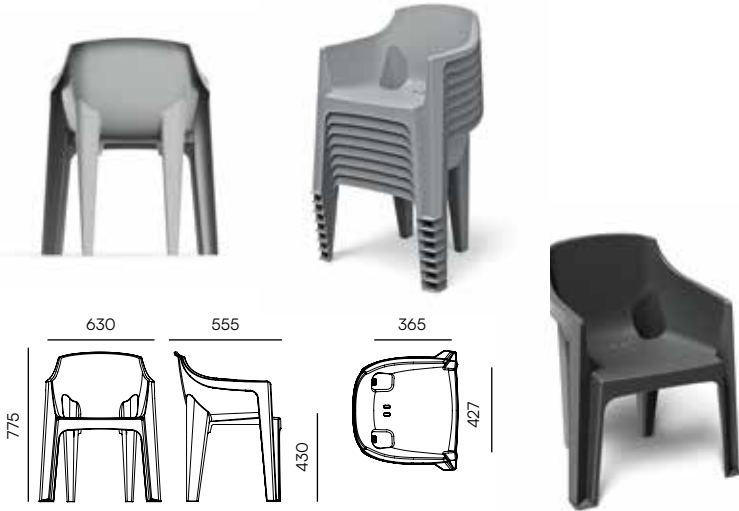

- white S449
- agate gray 423U
- carbon 446U

Turino

Chair with armrests

sku:	dimensions (mm): length /width /height	maximum weight:	packaging (pcs):	pallet height:	stackable:
FTUK668	630 x 555 x 775	110	48	~ 1950	✓

Ask about more logistics options.

**Simply comfortable.
Contract-ready for 2027.**

**New
Season
2027**



- white S449
- agate gray 423U
- carbon 446U

Treno

Chair with armrests

New

sku:	dimensions (mm): length /width /height	maximum weight:	packaging (pcs):	pallet height:	stackable:
FTRK658	595 x 550 x 810	110	42	~ 1850	✓

Ask about more logistics options.

Rotomoulded Design Collection

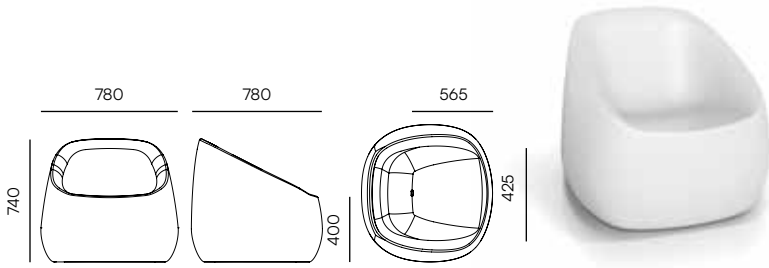

Vessco Armchair

New FVEK887R

sku:	dimensions (mm): length /width /height	maximum weight:	packaging (pcs):	pallet height:	stackable:
	780 x 780 x 740	110	4	~ 1750	-

Ask about more logistics options.

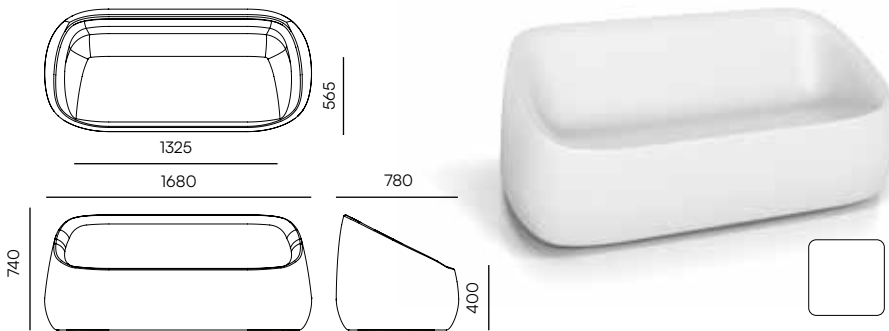

Vessco Sofa

New FVEK1787R

sku:	dimensions (mm): length /width /height	maximum weight:	packaging (pcs):	pallet height:	stackable:
	1680 x 780 x 740	2 x 110	2	~ 1850	-

Ask about more logistics options.

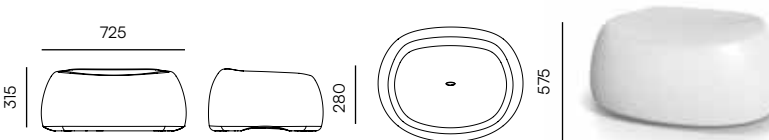

Vessco Stool

New FVEK763R

sku:	dimensions (mm): length /width /height	maximum weight:	packaging (pcs):	pallet height:	stackable:
	725 x 575 x 315	110	12	~ 1920	-

Ask about more logistics options.

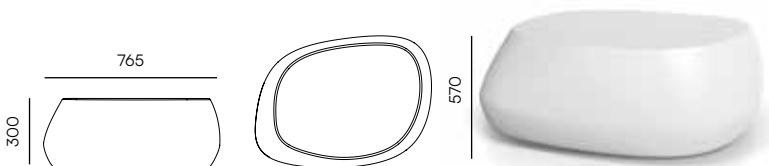

Vessco Coffee table

New FVES863R

sku:	dimensions (mm): length /width /height	maximum weight:	packaging (pcs):	pallet height:	stackable:
	765 x 570 x 300	100	12	~ 1940	-

Ask about more logistics options.

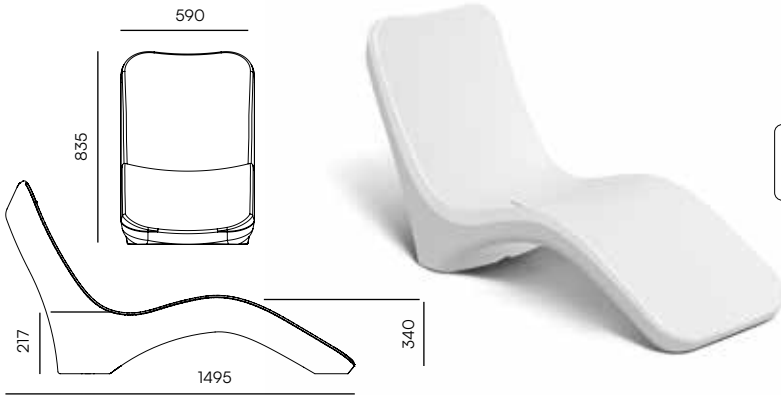

- 
mono white
440R
- 
urban gray
106R
- 
midnight anthracite
664R

Capre



Lounger

New FCAK1568R

sku:	dimensions (mm): length /width /height	maximum weight:	packaging (pcs):	pallet height:	stackable:
	1495 x 590 x 835	110	-	~	-

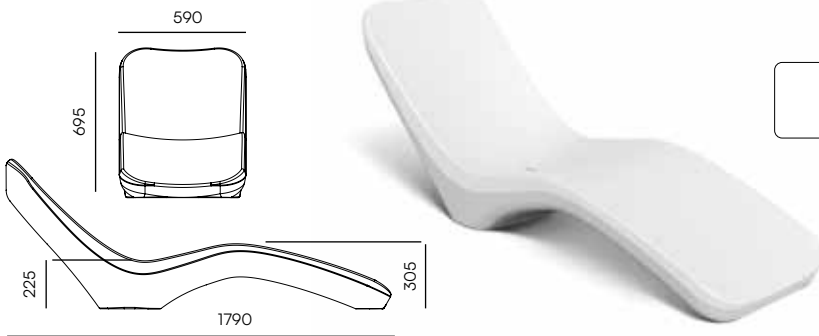
Ask about more logistics options.



- 
mono white
440R
- 
urban gray
106R
- 
midnight anthracite
664R

Capre

Lounger

New FCAK1867R

sku:	dimensions (mm): length /width /height	maximum weight:	packaging (pcs):	pallet height:	stackable:
	1790 x 590x 695	110	2	~1980	-

Ask about more logistics options.

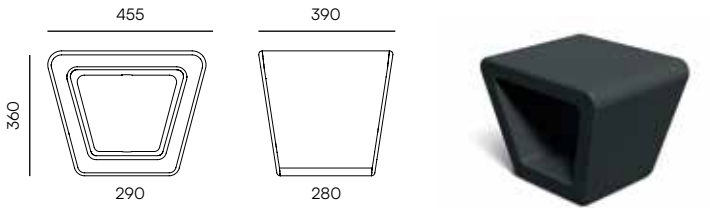

- 
mono white
440R
- 
urban gray
106R
- 
midnight anthracite
664R

Geno



Side table

New FGES544R

sku:	dimensions (mm): length /width /height	maximum weight:	packaging (pcs):	pallet height:	stackable:
	455 x 390 x 360	50	30	~ 1950	-

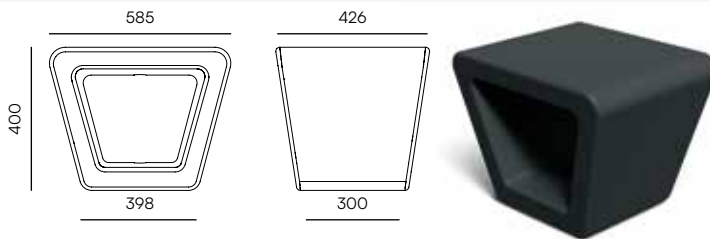
Ask about more logistics options.



- 
mono white
440R
- 
urban gray
106R
- 
midnight anthracite
664R

Geno

Side table

New FGES644R

sku:	dimensions (mm): length /width /height	maximum weight:	packaging (pcs):	pallet height:	stackable:
	585 x 426 x 400	-	16	~ 1750	-



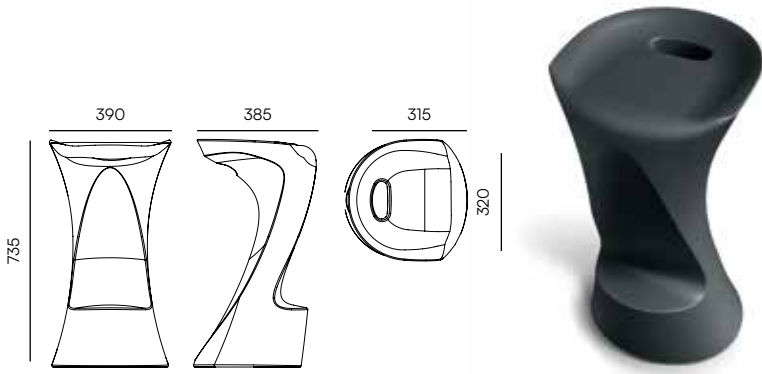

Ask about more logistics options.



Maleno

Bar chair

New FMAK447R

sku:	 dimensions (mm): length /width /height 390 x 385 x 735	 maximum weight: 110	 packaging (pcs): 12	 pallet height: ~ 1620	 stackable: -
------	---	--	---	--	---



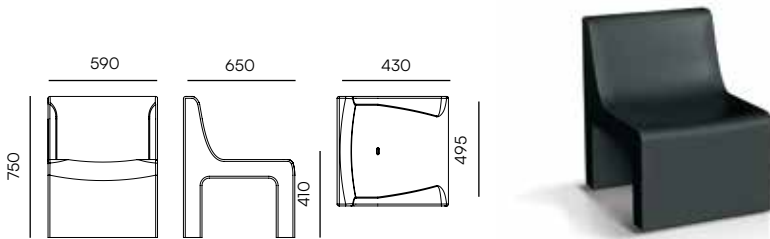

Ask about more logistics options.



Cone

Chair

New FCOK668R

sku:	 dimensions (mm): length /width /height 590 x 650 x 750	 maximum weight: 110	 packaging (pcs): 6	 pallet height: ~ 1920	 stackable: -
------	---	--	--	--	---



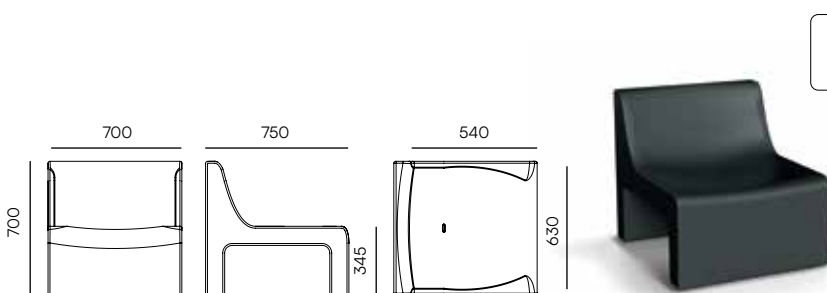

Ask about more logistics options.



Cone

Armchair

New FCOK787R

sku:	 dimensions (mm): length /width /height 700 x 750 x 700	 maximum weight: 110	 packaging (pcs): 4	 pallet height: ~ 1550	 stackable: -
------	---	--	--	--	---

Ask about more logistics options.

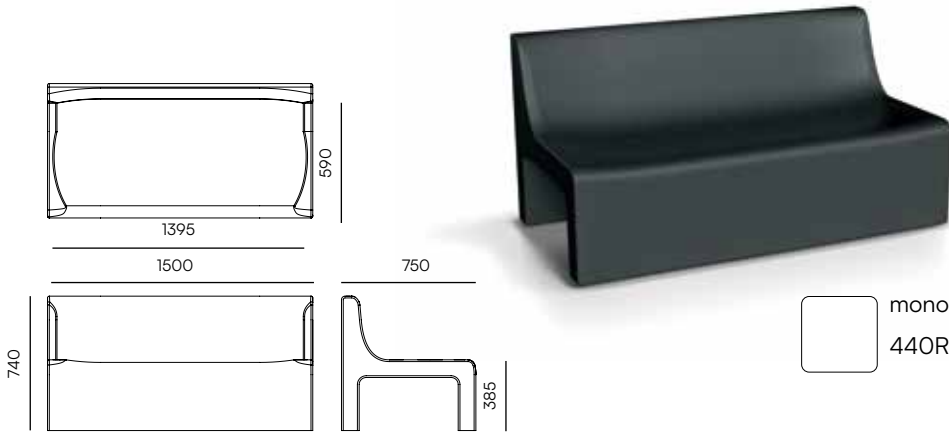

- 

mono white
440R
- 





urban gray
106R
- 

midnight
anthracite
664R

Cone

Sofa

New FCOK1587R

sku:	 dimensions (mm): length /width /height	 maximum weight:	 packaging (pcs):	 pallet height:	 stackable:
	1500 x 750 x 740	3 x 110	2	~ 1650	-

Ask about more logistics options.

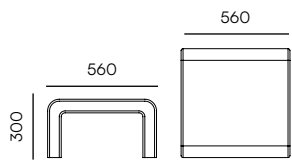

- 

mono white
440R
- 





urban gray
106R
- 

midnight
anthracite
664R

Cone

Small coffee table

New FCOS663R

sku:	 dimensions (mm): length /width /height	 maximum weight:	 packaging (pcs):	 pallet height:	 stackable:
	560 x 560 x 300	50	21	~ 1830	-

Ask about more logistics options.

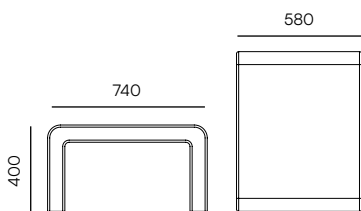

- 

mono white
440R
- 





urban gray
106R
- 

midnight
anthracite
664R

Cone





Medium coffee table

New FCOS764R

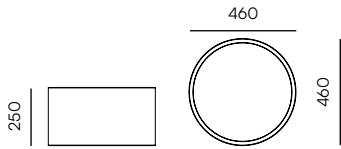
sku:	 dimensions (mm): length /width /height	 maximum weight:	 packaging (pcs):	 pallet height:	 stackable:
	740 x 580 x 400	100	12	~ 1630	-

Ask about more logistics options.



- | | | |
|--|--|---|
|  mono white
440R |  urban gray
106R |  midnight anthracite
664R |
|  salt
102GR |  macchiato
231R |  red ochre
220R |





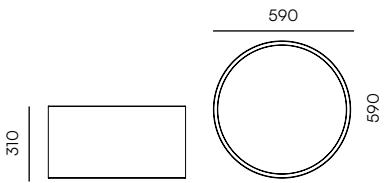

Oveo
Compact table

New FOVS553R

sku:	dimensions (mm): length /width /height	maximum weight:	packaging (pcs):	pallet height:	stackable:
	460 x 460 x 250	50	21	~ 1900	-

Ask about more logistics options.



- | | | |
|--|--|---|
|  mono white
440R |  urban gray
106R |  midnight anthracite
664R |
|  salt
102GR |  macchiato
231R |  red ochre
220R |





Oveo
Small table

New FOVS663R

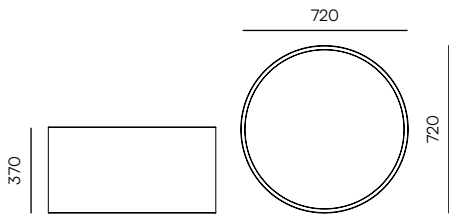
sku:	dimensions (mm): length /width /height	maximum weight:	packaging (pcs):	pallet height:	stackable:
	590 x 590 x 310	50	12	~ 1950	-

Ask about more logistics options.



- | | | |
|--|--|---|
|  mono white
440R |  urban gray
106R |  midnight anthracite
664R |
|  salt
102GR |  macchiato
231R |  red ochre
220R |



Oveo
Medium table

New FOVS774R

sku:	dimensions (mm): length /width /height	maximum weight:	packaging (pcs):	pallet height:	stackable:
	720 x 720 x 370	100	6	~ 1750	-

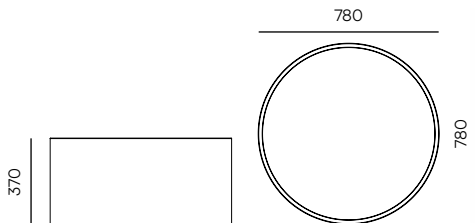
Ask about more logistics options.



- | | | |
|--|--|---|
|  mono white
440R |  urban gray
106R |  midnight anthracite
664R |
|  salt
102GR |  macchiato
231R |  red ochre
220R |

Oveo
Large table

New FOVS884R

sku:	dimensions (mm): length /width /height	maximum weight:	packaging (pcs):	pallet height:	stackable:
	780 x 780 x 370	100	6	~ 1750	-

Ask about more logistics options.

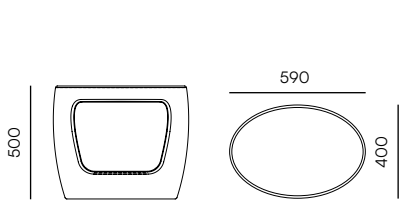

Solco

Side table

New FSL645R

sku: dimensions (mm): length /width /height
590 x 400 x 500

maximum weight:
-

packaging (pcs):
12

pallet height:
~ 1620

stackable:
-

Ask about more logistics options.

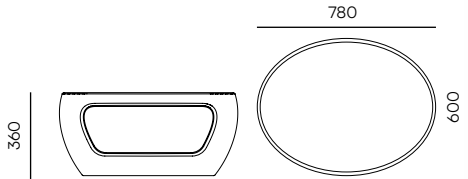

Solco

Coffee table

New FSL864R

sku: dimensions (mm): length /width /height
780 x 600 x 360

maximum weight:
-

packaging (pcs):
10

pallet height:
~ 1950

stackable:
-

Ask about more logistics options.

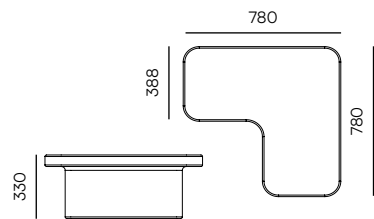

Modue

Coffee table

New FMOS883R

sku: dimensions (mm): length /width /height
780 x 780 x 330

maximum weight:
-

packaging (pcs):
10

pallet height:
~ 1800

stackable:
-

Ask about more logistics options.

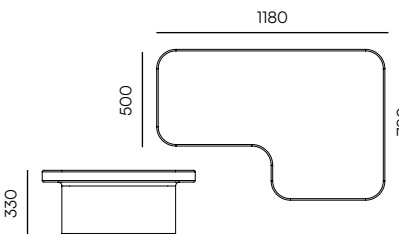

Modue

Large coffee table

New FMOS1283R

sku: dimensions (mm): length /width /height
1180 x 780 x 330

maximum weight:
-

packaging (pcs):
10
1200 x 1200

pallet height:
~ 1800

stackable:
-

Ask about more logistics options.

-  sand
101GR
-  macchiato
231R
-  charcoal
109GR
-  salt
102GR
-  lead
108GR
-  rust
200GR
-  corten steel
100GR
-  red ochre
220R
-  botanic green
300R

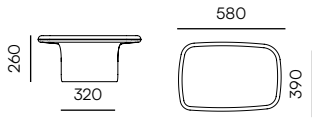

Senvo

Side table

New

FSES643R

sku:	dimensions (mm): length /width /height	maximum weight:	packaging (pcs):	pallet height:	stackable:
	580 x 390 x 260	-	24	~ 1720	-

Ask about more logistics options.

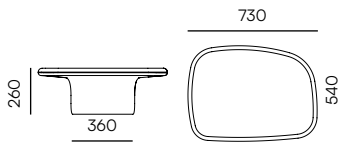

Available in nine colours shown above.

Senvo

Small coffee table

New

FSES753R

sku:	dimensions (mm): length /width /height	maximum weight:	packaging (pcs):	pallet height:	stackable:
	730 x 540 x 260	-	12	~ 1720	-

Ask about more logistics options.

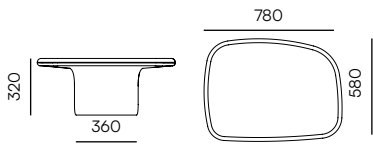

Available in nine colours shown above.

Senvo

Medium coffee table

New

FSES863R

sku:	dimensions (mm): length /width /height	maximum weight:	packaging (pcs):	pallet height:	stackable:
	780 x 580 x 320	-	10	~ 1760	-

Ask about more logistics options.

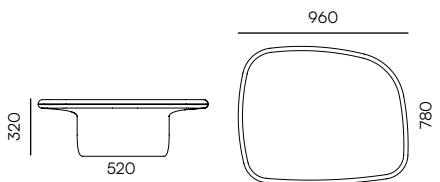

Available in nine colours shown above.

Senvo

Large coffee table

New

FSES1083R

sku:	dimensions (mm): length /width /height	maximum weight:	packaging (pcs):	pallet height:	stackable:
	960 x 780 x 320	-	5	~ 1760	-

Ask about more logistics options.

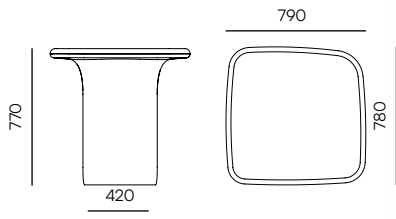

-  sand
101GR
-  macchiato
231R
-  charcoal
109GR
-  salt
102GR
-  lead
108GR
-  rust
200GR
-  corten steel
100GR
-  red ochre
220R
-  botanic green
300R

Senvo
Bistro table

sku:	dimensions (mm): length /width /height	maximum weight:	packaging (pcs):	pallet height:	stackable:
New FSES888R	790 x 780 x 770	-	4	~ 2150	-

Ask about more logistics options.

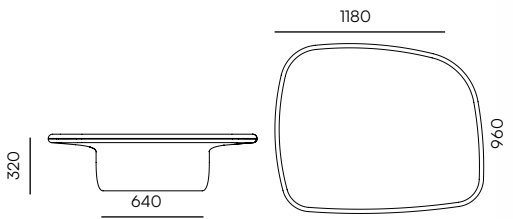





Available in nine colours shown above.

Senvo
Lounge table

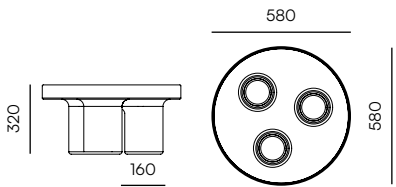
sku:	dimensions (mm): length /width /height	maximum weight:	packaging (pcs):	pallet height:	stackable:
New FSES12103R	1180 x 960 x 320	-	5 1200 x 1000	~ 1760	-

Ask about more logistics options.







-  sand
101GR
-  macchiato
231R
-  charcoal
109GR

Trito
Side table

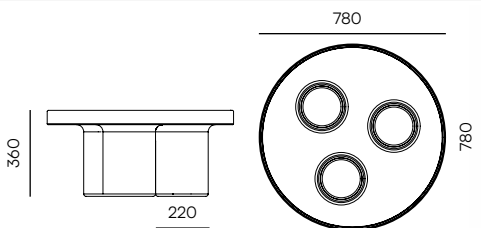
sku:	dimensions (mm): length /width /height	maximum weight:	packaging (pcs):	pallet height:	stackable:
New FTIS63R	580 x 580 x 290	-	24 1200 x 1200	~ 1900	-

Ask about more logistics options.



-  sand
101GR
-  macchiato
231R
-  charcoal
109GR

Trito
Coffee table

sku:	dimensions (mm): length /width /height	maximum weight:	packaging (pcs):	pallet height:	stackable:
New FTIS84R	780 x 780 x 360	-	10	~ 1950	-

Ask about more logistics options.

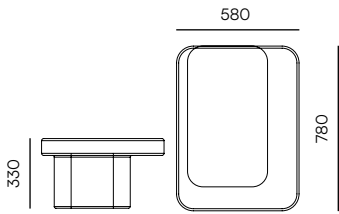

sand
101GR



macchiato
231R



charcoal
109GR

Giore

Lounge table

sku: dimensions (mm): length /width /height

580 x 780 x 330

maximum weight:

-

packaging (pcs):

10

pallet height:

~ 1800

stackable:

-

Ask about more logistics options.

New

FGIS863R

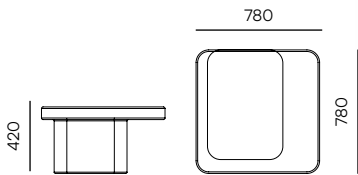

sand
101GR



macchiato
231R



charcoal
109GR

Giore

Large coffee table

sku: dimensions (mm): length /width /height

780 x 780 x 420

maximum weight:

-

packaging (pcs):

6

pallet height:

~ 1950

stackable:

-

Ask about more logistics options.

New

FGIS884R

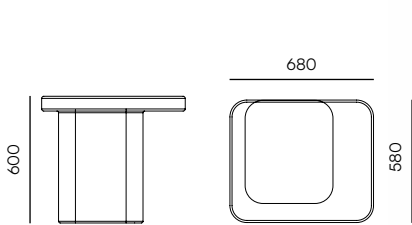

sand
101GR



macchiato
231R



charcoal
109GR

Giore

Medium coffee table

sku: dimensions (mm): length /width /height

680 x 580 x 600

maximum weight:

-

packaging (pcs):

6

pallet height:

~ 1950

stackable:

-

Ask about more logistics options.

New

FGIS766R

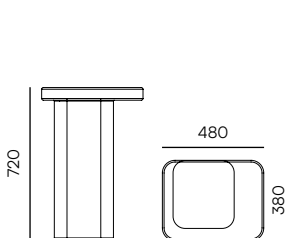

sand
101GR



macchiato
231R



charcoal
109GR

Giore

High side table

sku: dimensions (mm): length /width /height

480 x 380 x 720

maximum weight:

-

packaging (pcs):

12

pallet height:

~ 1650

stackable:

-

Ask about more logistics options.

New

FGIS547R

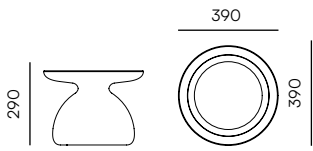

sand
101GR



macchiato
231R



charcoal
109GR

Cuplo

Side table

New FCUS43R

sku:	dimensions (mm): length /width /height
	390 x 390 x 290

maximum weight:
-

packaging (pcs):
36

pallet height:
~ 1900

stackable:
-

Ask about more logistics options.

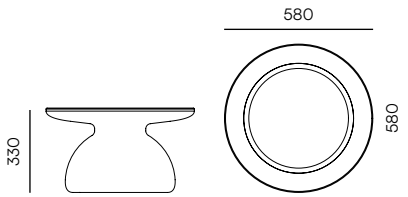

sand
101GR



macchiato
231R



charcoal
109GR

Cuplo

Coffee table

New FCUS63R

sku:	dimensions (mm): length /width /height
	580 x 580 x 330

maximum weight:
-

packaging (pcs):
30
1200 x 1200

pallet height:
~ 1800

stackable:
-

Ask about more logistics options.

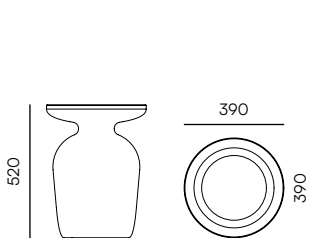

sand
101GR



macchiato
231R



charcoal
109GR

Cuplo

High side table

New FCUS45R

sku:	dimensions (mm): length /width /height
	390 x 390 x 520

maximum weight:
-

packaging (pcs):
18

pallet height:
~ 1710

stackable:
-

Ask about more logistics options.

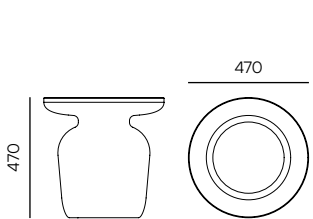

sand
101GR



macchiato
231R



charcoal
109GR

Cuplo

High side table

New FCUS55R

sku:	dimensions (mm): length /width /height
	470 x 470 x 470

maximum weight:
-

packaging (pcs):
9

pallet height:
~ 1560

stackable:
-

Ask about more logistics options.

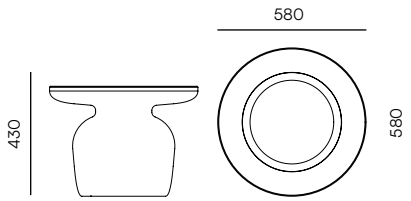

Cuplo

High coffee table

New FCUS64R

sku: dimensions (mm): length /width /height
580 x 580 x 430

maximum weight:
-

packaging (pcs):
16
1200 x 1200

pallet height:
~ 1870

stackable:
-

Ask about more logistics options.

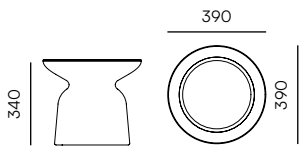

Lanzo

Side table

New FLAS43R

sku: dimensions (mm): length /width /height
390 x 390 x 340

maximum weight:
-

packaging (pcs):
30

pallet height:
~ 1850

stackable:
-

Ask about more logistics options.

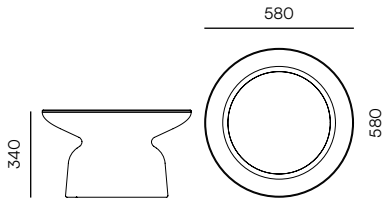

Lanzo

Medium coffee table

New FLAS63R

sku: dimensions (mm): length /width /height
580 x 580 x 340

maximum weight:
-

packaging (pcs):
20
1200 x 1200

pallet height:
~ 1850

stackable:
-

Ask about more logistics options.

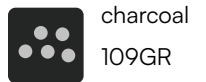
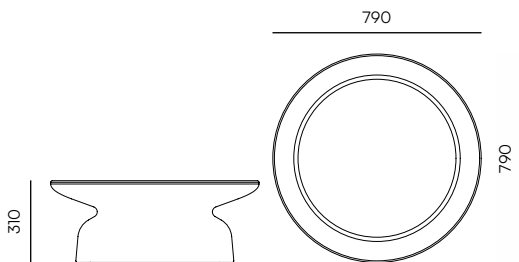

Lanzo

Large coffee table

New FLAS83R

sku: dimensions (mm): length /width /height
790 x 790 x 310

maximum weight:
-

packaging (pcs):
5

pallet height:
~ 1700

stackable:
-

Ask about more logistics options.

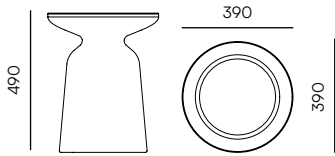

sand

101GR



macchiato

231R



charcoal

109GR

Lanzo

High side table

New

FLAS45R

sku:	dimensions (mm): length /width /height
	390 x 390 x 490

maximum weight:
-

packaging (pcs):
18

pallet height:
~ 1620

stackable:
-

Ask about more logistics options.

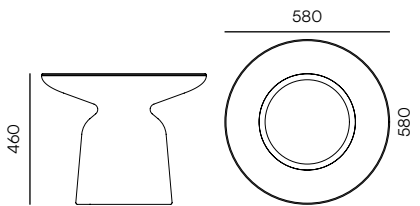

sand

101GR



macchiato

231R



charcoal

109GR

Lanzo

High coffee table

New

FLAS65R

sku:	dimensions (mm): length /width /height
	580 x 580 x 460

maximum weight:
-

packaging (pcs):
12
1200 x 1200

pallet height:
~ 1530

stackable:
-

Ask about more logistics options.

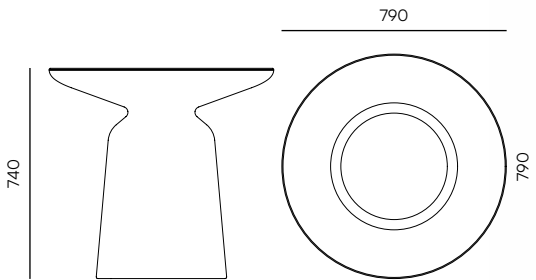

sand

101GR



macchiato

231R



charcoal

109GR

Lanzo

High coffee table

New

FLAS87R

sku:	dimensions (mm): length /width /height
	790 x 790 x 740

maximum weight:
-

packaging (pcs):
2

pallet height:
~ 1630

stackable:
-

Ask about more logistics options.

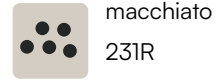
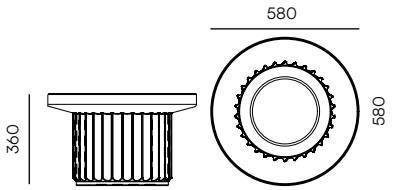

Soro

High coffee table

New FSOS64R

sku:	dimensions (mm): length /width /height
	580 x 580 x 360

maximum weight:
-

packaging (pcs):
10
1200 x 1200

pallet height:
~ 1950

stackable:
-

Ask about more logistics options.

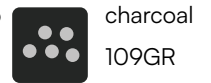
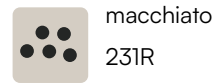
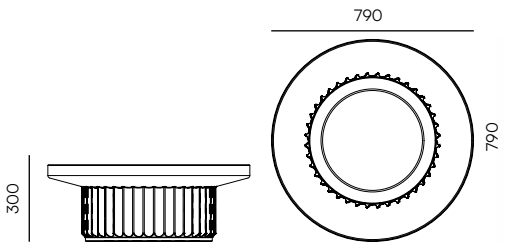

Soro
Coffee table

New FSOS83R

sku:	dimensions (mm): length /width /height
	790 x 790 x 300

maximum weight:
-

packaging (pcs):
6

pallet height:
~ 1950

stackable:
-

Ask about more logistics options.



Our exhibition spaces







We warmly invite you to visit the FERNE showroom at our headquarters in Rybarzowice, southern Poland.
In the photo: the BRENE collection.

A new brand based on over 30 years of experience.

We believe that everyone deserves to be surrounded by beauty and comfort. That's why we have created FERNE: a fresh brand of outdoor and indoor furniture, manufactured in Poland, in the heart of Europe. FERNE responds to the growing demand for furniture that is both comfortable and aesthetic. The brand is based on more than 30 years of Prosperplast's experience, offering high-quality products that are both comfortable and beautiful. Our furniture, produced in Central Europe, fits gardens, homes, and commercial spaces such as offices, cafes, and hotels.

FERNE is one of our newest brands. Prosperplast, a family company, specializes in innovative plastic processing technologies. We are a global organization with local production plants in small towns in Southern Poland, selling products in more than 90 countries.

Over the years, we have focused on injection molding, blow molding, and rotational molding — each offering different plastic forming methods, providing new uses and applications.

Our three decades of business operations have given us extensive experience and unique know-how. Our team of experts and modern machinery guarantee top quality. We rely on extensive infrastructure, with our own transport fleet and over 200 thousand square meters of warehouse and production space in Poland, Germany, Czechia, and Hungary. This allows us to successfully carry out projects and deliver innovative solutions that meet our customers' needs.

Since 1993, we have designed and produced numerous creative solutions for homes and gardens, including flower pots, rainwater tanks, garden tools, toolboxes, and storage systems. Now it's time for furniture.

Comfort-focused design.

User comfort is the priority of our brand. In designing FERNE furniture, we follow the latest global design trends, which contribute to the timelessness of our collections.

With in-depth knowledge of materials and their unique properties — such as elasticity, lightness, and resistance to damage — we create furniture that is not only comfortable for everyday use but also easy to transport and store.

Every FERNE furniture model is designed with the user's maximum comfort in mind, achieved without the need for additional upholstered elements. We use fully recyclable plastics and design our furniture with durability and long-term use in mind.



We design furniture with the utmost focus on user comfort.
In the photos: The design process of the BRENE collection.

Quality widely available.

We are deeply convinced that furniture of the best quality should be available to anyone who values beauty and comfort. At FERNE, our goal is to offer first-rate products at affordable prices. To achieve that, we cooperate with renowned design studios from Poland and other countries.

As Prosperplast, based on our 30 years of experience, we have used the existing distribution channels, advanced logistics, and efficient manufacturing processes to turn our vision into reality. What matters to us as well is building long-lasting and committed relationships with our business partners.

As we are in constant dialogue with our customers to make sure we understand their needs, we deliver timely and reliable solutions that meet their expectations.



FERNE



Rooted in local furniture heritage.

Hardworking, professional, and innovative — the people who live in our region have always been like this. That's why FERNE draws on the rich local furniture tradition that dates back to the 19th century. It was then that bentwood furniture manufacturing developed in the city of Bielsko-Biala and in the region, following the methods by Michael Thonet.

As an outstanding entrepreneur with a pioneer spirit, he launched the production of beautiful and functional beechwood furniture, accessible to the general public.

In the 1920s and 1930s, our region was also a leading manufacturing centre of nickel-plated bent tubes furniture. It was from here that Bauhaus icons, created by excellent designers such as Bruno Weil and Marcel Breuer, were sent out into the entire world.

Building on the legacy of Michael Thonet, we have written a new chapter of the local history of furniture manufacturing. At Prosperplast, we produce affordable, durable, and lightweight furniture with a timeless design aesthetic, at the same time taking up new challenges and using innovative plastics processing technologies.

Redefining excellence.

The Brene Collection by FERNE has been honored with the prestigious German Design Award 2025, recognizing its innovative design, exceptional functionality, and timeless aesthetic. This esteemed accolade, presented by the German Design Council, celebrates outstanding contributions to the field of design and highlights projects that push boundaries while remaining relevant in a global context.

As one of the most respected awards in the design industry, the German Design Award stands as a benchmark for excellence, rewarding products and concepts that redefine creativity and set new standards for innovation. This recognition highlights FERNE's approach to combining the legacy of traditional craftsmanship with modern design and responsible material use, aligned with contemporary lifestyles.

Brene

AWARD - WINNING COLLECTION.

The BRENE Collection by FERNE has received multiple prestigious honors.



One of the most prestigious international design awards, presented for over 70 years by iF International Forum Design GmbH, recognizes innovation, quality, and functionality in design. Celebrating excellence across various design disciplines, the award honors products that set new benchmarks in aesthetics and practical value.

In 2025, this distinction was awarded to the BRENE Collection during a prestigious ceremony held on 28 April at the Friedrichstadt-Palast in Berlin.



In the photo: Szymon Mrózek and Tymoteusz Mrózek representing the FERNE brand at the iF Design Award Night 2025.



A highly prestigious international design accolade, presented since 2012 by the German Design Council. This award is granted exclusively to projects nominated by experts, underscoring its exceptional status and rigorous selection process. It recognises innovation, quality, and aesthetics in design, honouring products that set new benchmarks in global design.

In 2025, the BRENE Collection was honoured with the German Design Award.

must have

One of the most prestigious Polish design awards, presented since 2011 by the Łódź Design Festival. This award recognises outstanding Polish products that seamlessly combine innovation, functionality, and aesthetics, with winners selected by an Expert Council. It serves as a mark of quality, underscoring the significance of Polish design in both national and international markets.

The award was presented in 2024 during the Łódź Design Festival — the most widely publicised event in Polish design.

“Functional Forms. The Story of Bentwood Furniture from the Podbeskidzie Region — Makers, People, and Products”

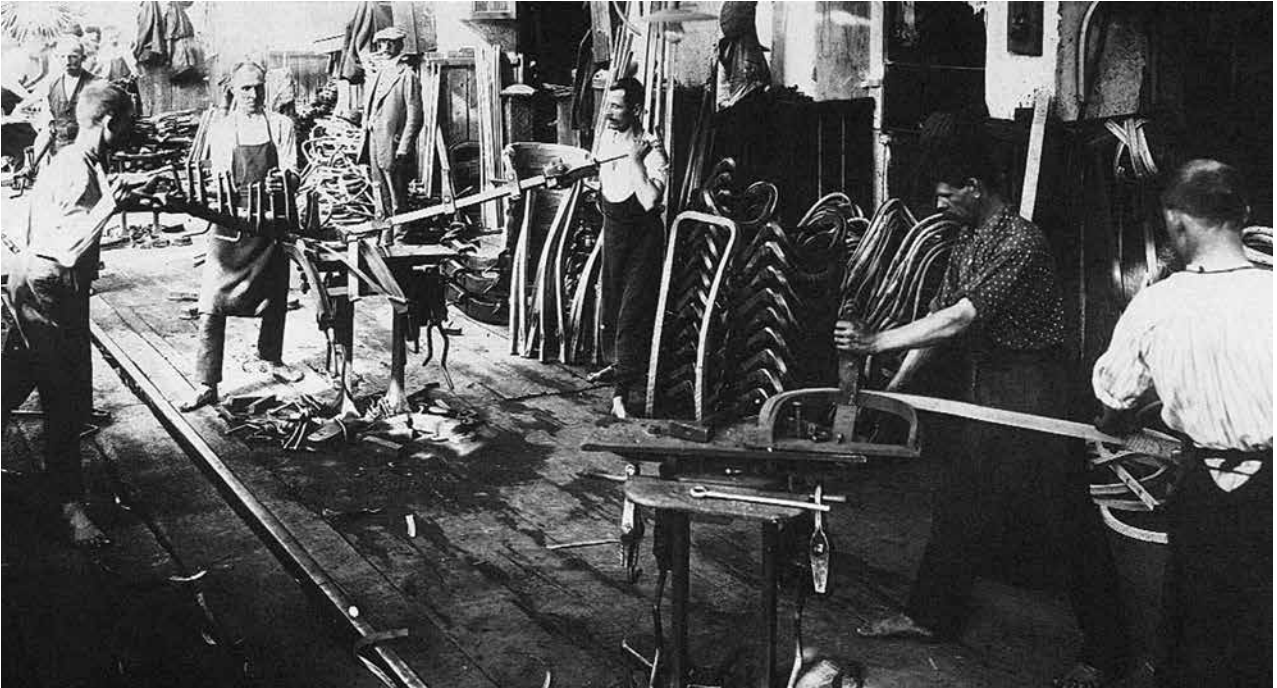

We are pleased to present a book that documents one of the most fascinating, yet still little-known chapters in the history of Polish design — the story of the bentwood furniture industry, which evolved over decades in the Podbeskidzie region. This richly illustrated publication brings together historical, social, and design perspectives. It is more than just a record of an industry — it is also a portrait of the makers, visionaries, and artisans who helped local designs reach international markets. For FERNE, the book serves as a vital source of inspiration, revealing the roots of the values that continue to define our brand: authenticity, durability, attention to detail, and respect for local heritage.



One of the book’s authors is Paweł Mrózek — President of Prosperplast and founder of the FERNE brand.

His personal involvement underlines the strong ties between our brand and the region’s traditions and history. FERNE was born out of a desire to foster a creative dialogue between craftsmanship and contemporary design.

Thanks to innovative technologies, we create furniture that is modern in form, yet deeply rooted in the values of local heritage.

FERNE is more than just a brand — it is the continuation of a story that began many years ago and lives on in every detail of our designs.

The book is available in three language versions: Polish, English, and German.
To request a copy, please contact our sales department.

have a seat.

over 90 countries worldwide

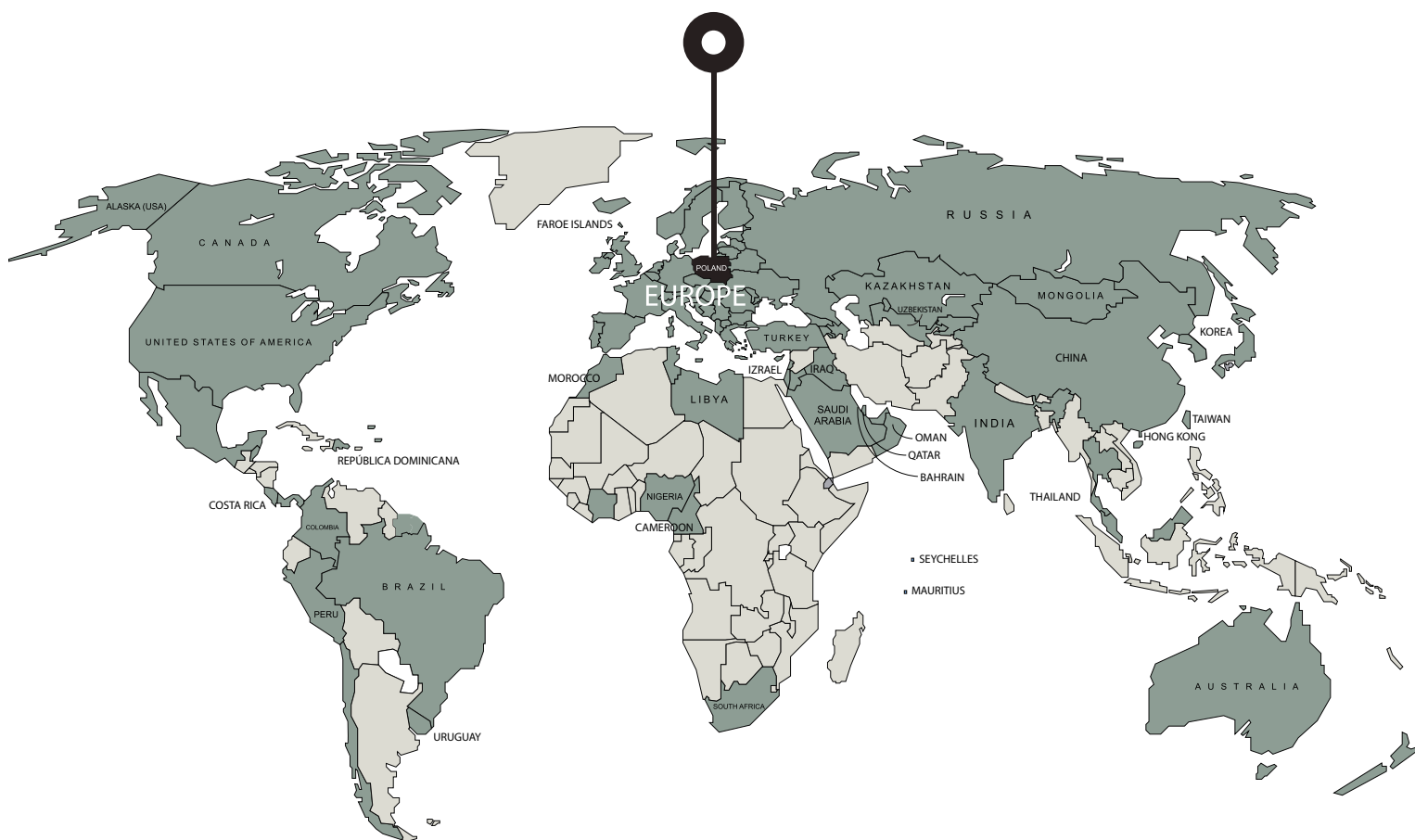

Through the continuous launch of innovative, diversified and high-quality products, and by maintaining the highest standards of partnership, Prosperplast has built a strong position in markets across the world.

Our products are currently distributed to more than 90 countries worldwide, with a growing network of satisfied partners and customers each year.

FOLLOW US

instagram: @ferne_furniture
facebook: @fernefurniture
ferne.pl

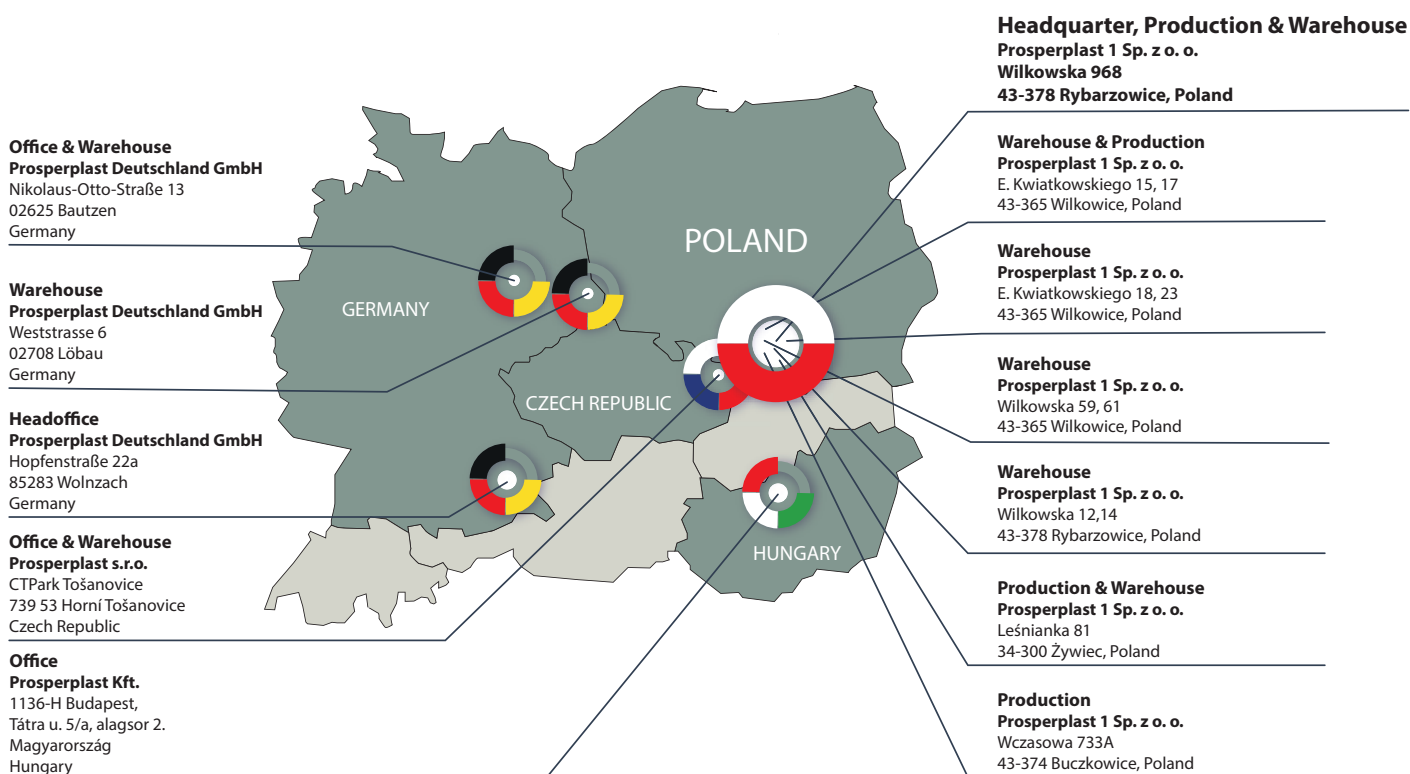

Contact us

Poland

Headquarter, Production & Warehouse

Prosperplast 1 Sp. z o. o.
 Wilkowska 968
 43-378 Rybarzowice
 Poland

tel. +48 33 817 70 03
 fax +48 33 817 60 81

biuro@prosperplast.pl
 office@prosperplast.pl
 www.prosperplast.pl

Germany

Headoffice

Prosperplast Deutschland GmbH
 Hopfenstraße 22a
 85283 Wolnzach
 Germany

tel. +49 8442 9628499
 fax +49 8442 9680853

kontakt@prosperplast.de
 www.prosperplast.de

Czech Republic

Office & Warehouse

Prosperplast s.r.o.
 CTPark Tošanovice
 739 53 Horní Tošanovice
 Czech Republic

tel. +420 553 034 443
 mob +420 605 499 544

info@prosperplast.cz
 www.prosperplast.cz

Hungary

Office

Prosperplast Kft.
 1136-H Budapest,
 Tátra u. 5/a, alagsor 2.
 Magyarország
 Hungary

mob +36 30 4095 710
 mob +36 30 2855 886

office@prosperplast.hu
 www.prosperplast.hu

Wszystkie prawa zastrzeżone przez Prosperplast 1 Spółka z o.o., a zawartość nie może być powielana, pobierana, rozpowszechniana, publikowana lub przekazywana w jakiegokolwiek formie i w jakikolwiek sposób, bez uprzedniej pisemnej zgody Prosperplast 1 Spółka z o.o.
 Niniejszy katalog nie stanowi oferty w rozumieniu obowiązujących przepisów. Za błędy w druku nie odpowiadamy.

All rights are reserved by Prosperplast 1 Spółka z o. o. and content may not be reproduced, downloaded, disseminated, published, or transferred in any form or by any means, except with the prior written permission of Prosperplast 1 Spółka z o.o.
 This catalogue does not constitute an offer within the meaning of applicable rules. We are not responsible for printing errors.

FERNE

ferne.pl

Prosperplast 1 Sp. z o.o.
Wilkowska 968
43-378 Rybarzowice
Poland